



Inspired by temperature

Betriebsanleitung · Operation manual · Manual de instrucciones · Manuel d'utilisation · Manuale de d'uso · 사용 설명서 · Manual de instruções · Инструкция по эксплуатации · Kullanım talimatı · 操作说明书 · Betriebsanweisung · Manual de instrucciones · 사용 설명서 · Инструкция по эксплуатации · Kullanım talimatı · 操作说明书 · Betriebsanweisung · Manual de instrucciones · 사용 설명서 · Инструкция по эксплуатации · Kullanım talimatı · 操作说明书

MPC RotaCool®

This documentation does not contain a device-specific technical appendix.

You can request the full operating instructions from info@huber-online.com. Please give the model designation and serial number of your temperature control unit in your e-mail.

huber



OPERATION MANUAL

MPC RotaCool®

RotaCool®

MPC®

This operation manual is a translation of the original operation manual.

The variants of the MPC controller. Mini Chiller/Unichiller, Unichiller, MPC Immersion circulator (top to bottom)

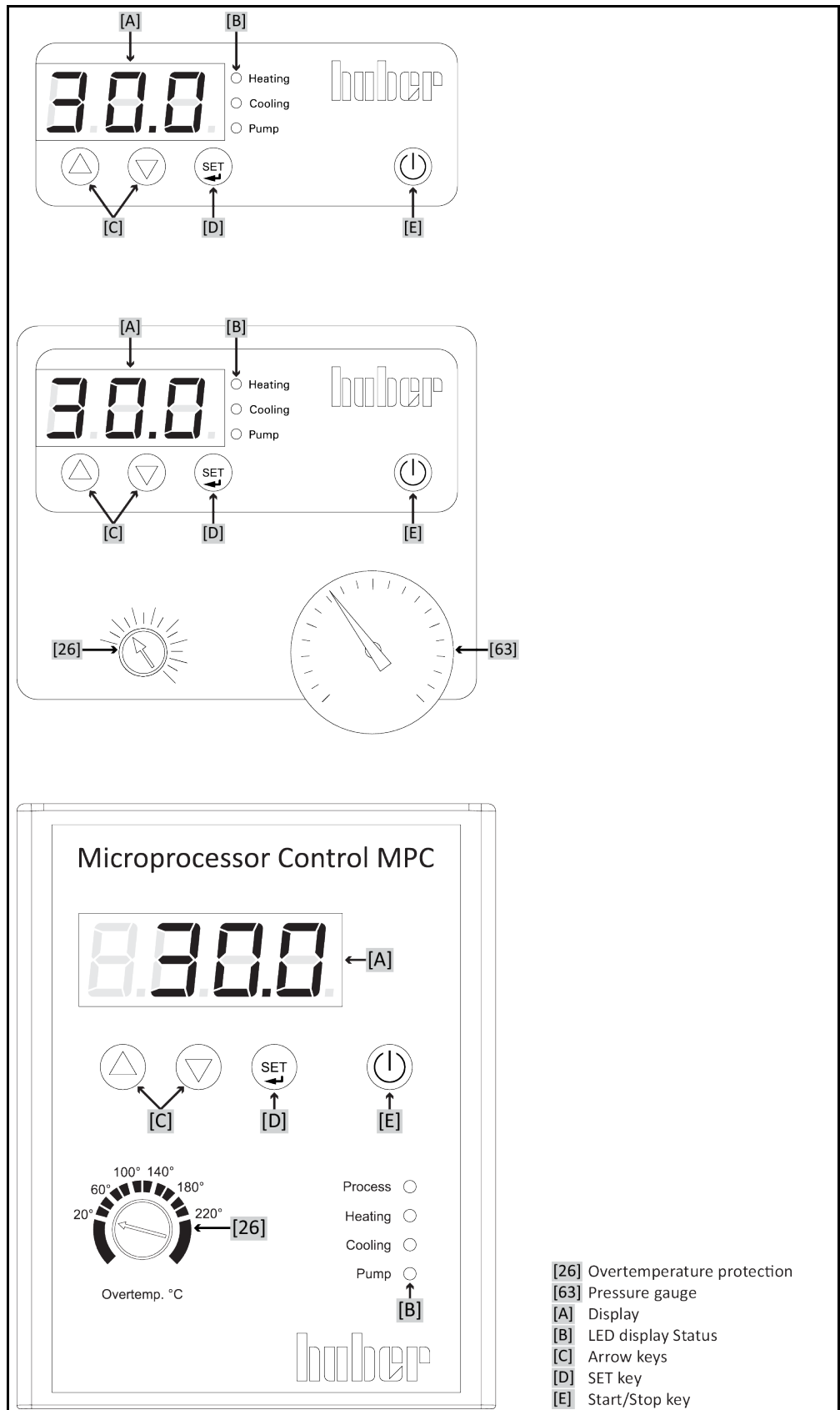

Table of contents

V2.3.0en/04.08.21//1.30

1	Introduction	12
1.1	Identification / symbols in the operation manual	12
1.2	Information on the EU Declaration of Conformity	12
1.3	Safety	12
1.3.1	Symbols used for Safety Instructions	12
1.3.2	Representation of safety identifiers on the temperature control unit	13
1.3.3	Proper operation	14
1.3.4	Reasonably foreseeable misuse	14
1.4	Responsible bodies and operators – Obligations and requirements	15
1.4.1	Obligations of the responsible body	15
1.4.1.1	Proper disposal of resources and consumables	15
1.4.1.2	Temperature control unit with natural refrigerants (NR)	16
1.4.1.3	Temperature control units with fluorinated greenhouse gases/refrigerants	17
1.4.2	Requirements for operators	17
1.4.3	Obligations of the operators	17
1.5	General information	18
1.5.1	Description of workstation	18
1.5.2	Safety devices to DIN 12876	18
1.5.3	Further protective devices	19
1.5.3.1	Power interruption	19
1.6	Exemplary illustrations of the cooling variants	19
1.6.1	Consequence of inadequate energy dissipation	20
2	Commissioning	21
2.1	In-plant transport	21
2.1.1	Lifting and transporting the temperature control unit	21
2.1.1.1	Temperature control unit with lifting eyes	21
2.1.1.2	Temperature control unit without lifting eyes	22
2.1.2	Mounting/removing leveling feet	22
2.1.3	Positioning the temperature control unit	23
2.1.3.1	Temperature control unit with casters	23
2.1.3.2	Temperature control unit without casters	23
2.2	Unpacking	23
2.3	Ambient conditions	23
2.3.1	EMC-specific notes	25
2.4	Installation conditions	25
2.5	Recommended temperature control hoses	25
2.6	Wrench sizes and torques	26
2.7	Preparations for operation	26
2.7.1	Unscrewing/activating the leveling feet (if any)	26
2.7.2	Opening/closing valves	27
2.7.3	Installing collecting container	27
2.7.4	Install additional work surface (optional)	27
2.7.5	Connecting the functional earth	27
2.8	Connecting externally closed application	28
2.8.1	Connecting an externally closed application	28
2.9	Connecting to the power supply	28

2.9.1	Connection using socket with protective earth (PE).....	28
2.9.2	Connection via hard wiring.....	29
3	Function description	30
3.1	Function description of the temperature control unit	30
3.1.1	General functions.....	30
3.1.2	Other functions.....	30
3.2	Information on the thermal fluids	30
3.3	To be noted when planning the test	31
3.4	Display and control instruments.....	32
3.4.1	Display.....	32
3.4.2	LED display status	32
3.4.3	Arrow keys	32
3.4.4	SET key	32
3.4.5	Start/Stop key	32
3.5	Menu function	33
3.6	Function examples	33
3.6.1	Display setpoint	33
3.6.2	Set/change setpoint.....	33
3.6.3	Changing the Auto-Start function	33
4	Setup mode	35
4.1	Setup mode	35
4.1.1	Turning on the temperature control unit	35
4.1.2	Turning off the temperature control unit.....	35
4.1.3	Setting the setpoint	35
4.2	Filling, venting and draining	35
4.2.1	Filling and venting externally closed application	36
4.2.2	Draining externally closed applications	37
5	Normal operation	38
5.1	Automatic operation	38
5.1.1	Temperature control.....	38
5.1.1.1	Starting the temperature control process.....	38
5.1.1.2	Ending the temperature control process	38
6	Service/maintenance	39
6.1	Displays in the event of faults.....	39
6.2	Maintenance.....	39
6.2.1	Function check and visual inspection	40
6.2.2	Replacing temperature control hoses.....	41
6.2.3	Clean liquefier fins (air-cooled temperature control unit)	41
6.3	Thermal fluid inspection, replacement and circuit cleaning.....	42
6.3.1	Thermal fluid replacement	42
6.3.1.1	Externally closed application	42
6.3.2	Rinsing the thermal fluid circuit.....	42
6.4	Cleaning the surfaces	44
6.5	Inspect the mechanical seal.....	44
6.6	Plug contacts.....	44
6.7	Decontamination/repairs	44
7	Shutting down	46
7.1	Safety instructions and basic principles	46

7.2	Switch-off	46
7.3	Draining the temperature control unit.....	47
7.4	Deinstalling the collecting container.....	47
7.5	Uninstalling an external application	47
7.6	Packing	47
7.7	Shipping.....	47
7.8	Disposal	48
7.9	Contact data	48
7.9.1	Telephone number: Customer Support	48
7.9.2	Telephone number: Sales	48
7.9.3	Email address: Customer Support.....	48
7.10	Certificate of Compliance	49
8	Annex	50

Foreword

Dear Customer,

Thank you for choosing a temperature control unit from Peter Huber Kältemaschinenbau SE. You have made a good choice. Thank you for your trust.

Please read the operation manual carefully before putting the unit into operation. Strictly follow all notes and safety instructions.

Follow the operation manual with regard to transport, start-up, operation, maintenance, repair, storage and disposal of the temperature control unit.

We fully warrant the temperature control unit for the specified intended operation.

The models listed on page 5 are referred to in this operation manual as temperature control units and Peter Huber Kältemaschinenbau SE as Huber company or Huber.

Liability for errors and misprints excluded.

The following trademarks and the Huber logo are registered trademarks of Peter Huber Kältemaschinenbau SE in Germany and/or other countries worldwide: BFT®, CC®, Chili®, Com.G@te®, Compatible Control®, CoolNet®, DC®, E-grade®, Grande Fleur®, Huber Piccolo®, KISS®, Minichiller®, Ministat®, MP®, MPC®, Peter Huber Minichiller®, Petite Fleur®, Pilot ONE®, RotaCool®, Rotostat®, SpyControl®, SpyLight®, Tango®, TC®, UC®, Unical®, Unichiller®, Unimotive®, Unipump®, Unistat®, Unistat Tango®, Variostat®. The following trademarks are registered in Germany to DWS Synthesetechnik: DW-Therm®, DW-Therm HT®. The following trademark is a registered trademark of BASF SE: Glystantin®.

1 Introduction

1.1 Identification / symbols in the operation manual

The following identifications and symbols are used in the texts and illustrations.

Overview	Identification / symbol	Description
	→	Reference to information / procedure.
	»TEXT«	Reference to a chapter in the operation manual. In the digital version, the text is clickable.
	>TEXT< [NUMBER]	Reference to the wiring diagram in the annex. The designation and the search digit are specified.
	>TEXT< [LETTER]	Reference to a drawing in the same paragraph. The designation and the search digit are specified.
	▪	List, first level
	–	List, second level

1.2 Information on the EU Declaration of Conformity





 The equipment complies with the basic health and safety requirements of the European Directives listed below:

- Machinery Directive
- Low Voltage Directive
- EMC Directive

1.3 Safety

1.3.1 Symbols used for Safety Instructions

Safety instructions are marked by the below combinations of pictograms and signal words. The signal word describes the classification of the residual risk when disregarding the operation manual.

	Denotes an immediate hazardous situation that will result in death or serious injuries.
	Denotes a general hazardous situation that may result in death or serious injuries.
	Denotes a hazardous situation that can result in injury.
	Denotes a situation that can result in property material damage.
	Denotes important notes and usable hints.

Safety information and procedure

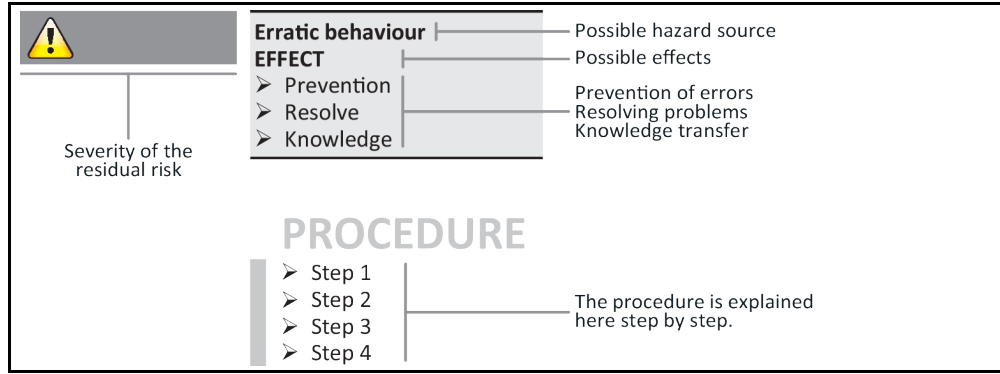

The safety information in this operation manual is designed to protect the operating company, the operator and the equipment from damage. First inform yourself about any residual risks due to misuse before you start an operation.

1.3.2 Representation of safety identifiers on the temperature control unit

The following pictograms are used as safety identifiers. The table gives an overview of the safety identifiers used here.

Identifier	Description
Mandatory sign	
	- Observe the instructions
Warning sign	
	- General warning sign - Observe the instructions
	- Warning of electrical voltage
	- Warning of hot surface
	- Warning of flammable substances

1.3.3 Proper operation



DANGER

Operating the temperature control unit in a potentially explosive area

DEATH THROUGH EXPLOSION

- Do NOT install or start up the temperature control unit within an ATEX zone.



WARNING

Improper use

SERIOUS INJURY AND PROPERTY DAMAGE

- Store the operation manual where it is easy to access in close proximity to the temperature control unit.
- Only adequately qualified operators may work with the temperature control unit.
- Operators must be trained before handling the temperature control unit.
- Check that the operators have read and understood the operation manual.
- Define precise responsibilities of the operators.
- Personal protective equipment must be provided to the operators.
- Be sure to follow the responsible body's safety rules to protect life and limb and to limit damages!

NOTE

Modifications to the temperature control unit by third-parties

DAMAGE TO THE TEMPERATURE CONTROL UNIT

- Do not allow third parties to make technical modifications to the temperature control unit.
- The EU declaration of conformity becomes invalid if any modifications are made to the temperature control unit without the approval of Huber.
- Only specialists trained by Huber may carry out modifications, repairs or maintenance work.
- **The following must be observed without fail:**
- Only use the temperature control unit in a fault-free condition!
- Have the start-up and repairs carried out by specialists only!
- Do not ignore, bypass, dismantle or disconnect any safety devices!

The temperature control unit must not be used for any purposes other than temperature control in accordance with the operation manual.

The temperature control unit is made for industrial use. The temperature control unit is used to maintain the temperature of applications, such as glass or metal reactors or other expedient items in laboratories and industry. Flow-through coolers and calibration baths must be used only in combination with Huber temperature control units. Only use thermal fluids suitable for the overall system. The cooling or heating capacity is provided at the pump connections or - where present - in the tempering bath. For the technical specification, refer to the datasheet. → From page 50, section »Annex«. Install, set up and operate the temperature control unit according to the instructions in this operation manual. Any failure to comply with the operation manual is considered as improper operation. The temperature control unit was manufactured according to the state of the art and the recognized safety rules and regulations. Safety devices are installed in your temperature control unit.

1.3.4 Reasonably foreseeable misuse

Use with medical devices (e.g. in Vitro diagnostic procedure) or for direct foodstuff temperature control is **NOT** permissible.

The temperature control unit must **NOT** be used for any purposes other than temperature control in accordance with the operation manual.

The manufacturer accepts **NO** liability for damage caused by **technical modifications** to the temperature control unit, **improper handling** or use of the temperature control unit if the operation manual is **not observed**.

1.4 Responsible bodies and operators – Obligations and requirements

1.4.1 Obligations of the responsible body

The operation manual is to be stored where it is easy to access in close proximity to the temperature control unit. Only adequately qualified operators (e.g. chemists, CTA, physicists etc.) are permitted to work with the temperature control unit. Operators must be trained before handling the temperature control unit. Check that the operators have read and understood the operation manual. Define precise responsibilities of the operators. Personal protective equipment must be provided to the operators.

- The responsible body must install a condensation water / thermal fluid drip tray below the temperature control unit.
- The use of a drip tray may be prescribed by national legislation for the installation area of the temperature control unit (incl. accessory). The responsible body must check and apply the national regulations applicable for it accordingly.
- The temperature control unit complies with all applicable safety standards.
- Your system, which uses our temperature control unit, must be equally safe.
- The responsible body must design the system to ensure it is safe.
- Huber is not responsible for the safety of your system. The responsible body is responsible for the safety of the system.
- Although the temperature control unit provided by Huber meets all the applicable safety standards, integration into a system may give rise to hazards that are characteristic of the other system's design and beyond the control of Huber.
- It is the responsibility of the system integrator to ensure that the overall system, into which this temperature control unit is integrated, is safe.
- The >Mains isolator< [36] (if present) can be locked in the off position to facilitate safe system installation and maintenance of the temperature control unit. It is the responsibility of the responsible body to develop any lock-out/tag-out procedure for the energy source in accordance with local regulations (e.g. CFR 1910.147 for the US).

1.4.1.1 Proper disposal of resources and consumables

Do comply with all national disposal regulations applicable for you. Contact your local waste management company for any questions concerning disposal.

Overview	Material / Aids	Disposal / Cleaning
	Packaging material	Keep the packaging material for future use (e.g. transport).
	Thermal fluid	Please refer to the safety data sheet of the thermal fluid used for information on its proper disposal. Use the original thermal fluid container when disposing it.
	Filling accessories, e.g. beaker	Clean the filling accessories for reuse. Make sure that the materials and cleaning agents used are properly disposed of.
	Aids such as towels, cleaning cloths	Tools used to take up spilled thermal fluid must be disposed of in the same fashion as the thermal fluid itself. Tools used for cleaning must be disposed of depending on the cleaning agent used.
	Cleaning agents such as stainless steel cleaning agents, sensitive-fabrics detergents	Please refer to the safety data sheet of the cleaning agent used for information on its proper disposal. Use the original containers when disposing of large quantities of cleaning agents.
	Consumables such as air filter mats, temperature control hoses	Please refer to the safety data sheet of the consumables used for information on their proper disposal.

1.4.1.2 Temperature control unit with natural refrigerants (NR)



Over 8 g refrigerant per m³ room air
DEATH OR SERIOUS INJURY DUE TO EXPLOSION

- Observe the rating plate (amount of natural refrigerant contained) and the room size (maximum room concentration of natural refrigerant in case of leakage) when installing the temperature control unit.
- Over 8 g refrigerant per m³ room air: A gas warning sensor must be fitted and functioning.
- The gas warning sensor must be calibrated and maintained at regular intervals (between 6 and 12 months).
- The temperature control unit is not approved for operation **in an ATEX zone**.

Huber products with natural refrigerants work with numerous proven, safe and highly-sustainable technologies. The relevant standards and regulations for temperature control units with natural refrigerants contain a number of stipulations, the importance of complying with which is set out below. Please additionally: → Page 14, section »**Proper operation**«.

Huber temperature control units are constructed to be permanently sealed and are carefully checked for leak tightness. Temperature control units with more than 150 g natural refrigerant are equipped with an additional gas warning sensor.

For the filling capacity of the temperature control unit, refer to the data sheet. → From page 50, section »**Annex**«. Or to the rating plate on the back of the temperature control unit. Please also consider: → Page 23, section »**Ambient conditions**« and → Page 25, section »**Installation conditions**«.

Classifying the application field

Class of application field	Application field	Example of the installation location	Max. quantity of refrigerant	AND	Max. permissible quantity above ground level (GL)
A	General	Publicly accessible area in a public building	8 g/m ³ ambient air		1.5 kg
B	Monitored	Laboratories			2.5 kg
C	Access only for authorized persons	Production equipment			10.0 kg
Temperature control units with more than 1 kg refrigerant must not be installed below ground level (GL) .					

Temperature control units with up to 150 g natural refrigerant

- The temperature control unit has been constructed to the requirements of EU and EFTA countries.
- Use the table as guidance for classifying the application field. Respect the max. refrigerant quantity stated therein.

Temperature control units with more than 150 g natural refrigerant

- The temperature control unit has been constructed to the requirements of EU and EFTA countries.
- Use the table as guidance for classifying the application field. Respect the max. refrigerant quantity or the permissible highest quantity above ground level (GL) stated therein.
- For more information about the pre-installed gas detection sensor:
 - The built-in gas detection sensor enables a **safety shutdown at 20% of the lower explosive limit via a power disconnect relay that is to be installed by the responsible body**. The temperature control unit is thus switched off early and safely in case of fault.
 - A **24 V DC external power supply** must be available for the pre-installed gas warning sensor. The alarm output of the gas warning sensor uses a 4 - 20 mA signal. Please refer to the data sheet of the gas warning sensor for further technical information. A **separate processing unit is available as an accessory** for the control of the power disconnect relay. The processing unit provides a potential-free switching contact and simultaneously provides the power supply and analysis of the gas warning sensor. Both variants require the respon-

sible body to provide the necessary dimensioning and installation. Please refer to the data sheet of the gas warning sensor for the technical information necessary for the installation. The alarm of the gas detection system can be connected to the responsible body's alarm control unit. The responsible body is responsible for this and for the other measures.

- The responsible body is responsible for the **calibration of the gas detection sensor** prior to initial operation and the observance of calibration and maintenance intervals according to the operation manual. We recommend to set calibration and maintenance intervals between 6 and 12 months if no information is provided. For increased safety requirements, shorter intervals can be specified. On request we will recommend a specialist company to carry out the calibration and maintenance.

1.4.1.3 Temperature control units with fluorinated greenhouse gases/refrigerants

F gases regulation (EC) No. 517/2014 of April 16, 2014, on fluorinated greenhouse gases, and repealing Regulation (EC) No. 842/2006.

These regulations deal with all systems that contain fluorinated refrigerants. The substances dealt with in Directive (EC) No. 1005/2009 of the European Parliament and of the Council of 16 September 2009 that deplete the ozone layer are excluded (CFC/HCFC).

The directive regulates the reduction of the emission, utilization, recovery, and destruction of certain fluorinated greenhouse gases. It also regulates the identification and disposal of products and devices that contain these gases. Since July 4, 2007, responsible bodies must check their stationary refrigeration systems for leaks at regular intervals, and have any leaks eliminated immediately.

Directive (EC) No. 303/2008 contains stipulations on the training and certification of companies and personnel that are permitted to execute the specified activities.

Obligations of the responsible bodies:

- Directive (EC) No. 842/2006 already imposed a number of obligations upon responsible bodies regarding certain fluorinated greenhouse gases. The new Ordinance on Fluorinated Greenhouse Gases upholds these to a large extent. Some duties are added while others are designed differently by this new ordinance. Please refer to the text of this ordinance for a complete overview of the individual responsibilities of responsible bodies.
- General obligation to reduce emissions.
- Only certified companies may maintain, repair or decommission refrigeration systems. The responsible bodies must verify that these companies are certified.
- Regular leak tests of stationary refrigeration systems by certified personnel (such as Huber service engineers). The required test interval is based on the refrigerant filling capacity and the type of refrigerant, converted to CO₂ equivalent.
- Responsibility of responsible bodies operating a plant to recover F-gases by certified personnel.
- Obligatory documentation requirement in the refrigeration system's operation manual, specifying type and volume of refrigerant used or recovered. The responsible body must keep the records for at least 5 years after their creation and present it to the responsible authority upon request.
- Temperature control units with natural refrigerants (NR) are exempt from this Directive.
- Please refer to the data sheet or rating plate of your temperature control unit for the quantity and type of refrigerant.
- Additional information about the definition of the inspection interval can be found on our website.

1.4.2 Requirements for operators

Work on the temperature control unit is reserved for appropriately qualified specialists, who have been assigned and trained by the responsible body to do so. Operators must be at least 18 years old. Under 18-year olds may operate the temperature control unit only under the supervision of a qualified specialist. The operator is responsible vis-a-vis third-parties in the work area.

1.4.3 Obligations of the operators

Carefully read the operation manual before operating the temperature control unit. Please observe the safety instructions. When operating the temperature control unit, wear appropriate personal protective equipment (e.g. safety goggles, protective gloves, non-slip shoes).

1.5 General information

1.5.1 Description of workstation

The workstation is located at the control panel in front of the temperature control unit. The workstation is determined by the customer's connected peripheries. Accordingly, it must be designed safe by the responsible body. The workstation design also depends on the applicable requirements of the German occupational health and safety regulations [BetrSichV] and the risk analysis for the workstation.

1.5.2 Safety devices to DIN 12876

The rating of your temperature control unit is stated on the data sheet in the appendix.

Rating of laboratory thermostats and laboratory baths	Classification	Temperature control medium	Technical requirements	Identification ^{d)}
	I	Non-combustible ^{a)}	Overheat protection ^{c)}	NFL
	II	Combustible ^{b)}	Adjustable overheat protection	FL
	III	Combustible ^{b)}	Adjustable overtemperature protection and additional low-level protection	FL

^{a)} Usually water; other fluids only if non-combustible even within the temperature range of an individual fault.
^{b)} The temperature control media must have a fire point of ≥ 65 °C.
^{c)} The overheat protection can, for instance, be realized using a suitable fill level sensor or a suitable temperature limiter.
^{d)} Optional at the choice of the manufacturer.

- Temperature control units with heating correspond to class number III/FL. These temperature control units are characterized by an "H" in the device name.
- Temperature control units without heating correspond to class number I/NFL.

Overview of the temperature thresholds

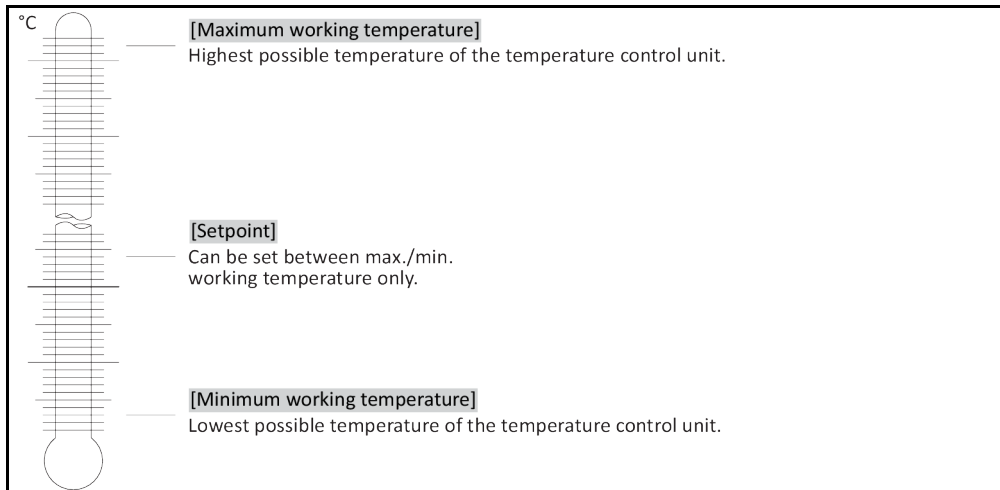

1.5.3 Further protective devices

INFORMATION

Emergency strategy – interrupt the power grid connection!

To determine the type of switch or switch combination your temperature control unit is equipped with, please refer to the wiring diagram. → From page 50, section »Annex«.

Temperature control units with >Mains isolator< [36] (red/yellow or gray): Turn the >Mains isolator< [36] to the "0" position.

Temperature control units with >Mains isolator< [36] (red/yellow) and additional >Appliance switch< [37] (gray): Turn the >Mains isolator< [36] to the "0" position. Then turn the >Appliance switch< [37] to the "0" position!

Temperature control units with >Mains isolator< [36] (gray) and >Emergency stop switch< [70] (red/yellow): Press the >Emergency stop switch< [70]. Then turn the >Main switch< [36] to the "0" position!

Temperature control units with >Mains switch< [37]: Power supply via socket: Disconnect the temperature control unit from the power supply. Then turn the >Mains isolator< [37] to the "0" position! Power supply via hard wiring: Disconnect the power grid supply by means of the building's circuit breaker. Then turn the >Mains isolator< [37] to the "0" position!

Temperature control units without a switch or inside a protective housing: Connection via socket: Disconnect the temperature control unit from the power supply. Connection via hard wiring: Disconnect the power grid supply by means of the building's circuit breaker!

1.5.3.1 Power interruption

Following a power outage (or when switching on the temperature control unit), this function can be used to determine how the temperature control unit is supposed to respond.

Auto start function switched off

The temperature control is started only by manual input when the temperature control unit is turned on.

Auto start function switched on

The temperature control unit is set to the same state it was in before the power outage. For example, before the power outage: Temperature control is off; after power outage: Temperature control is off. If temperature control was active during a power outage, the process will automatically continue after the power outage.

→ Page 33, section »Changing the Auto-Start function«.

1.6 Exemplary illustrations of the cooling variants

Example: Air and water cooling

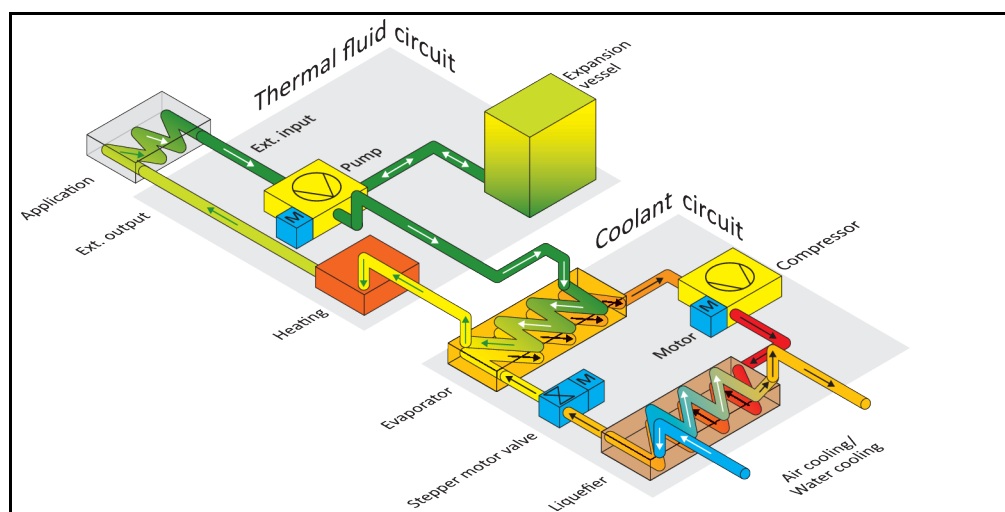

Air cooling: Air inlet

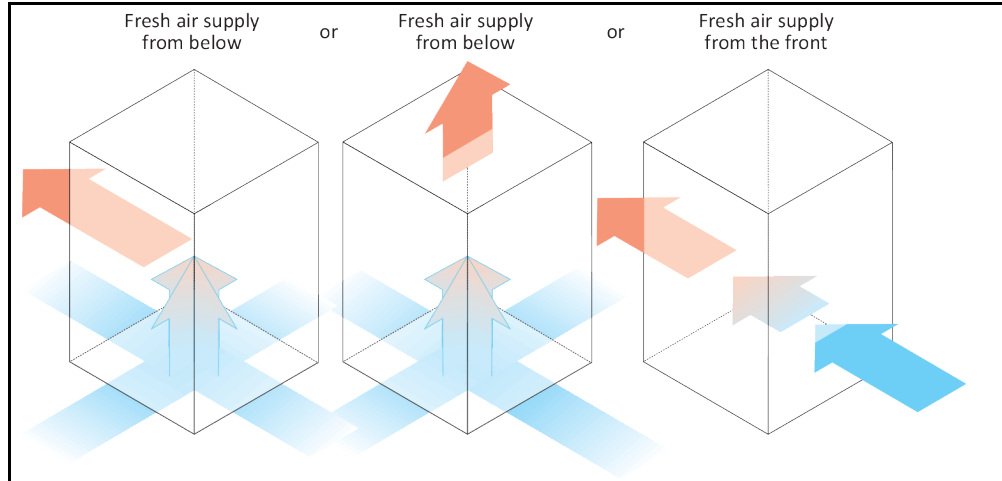

Water cooling: Water connection

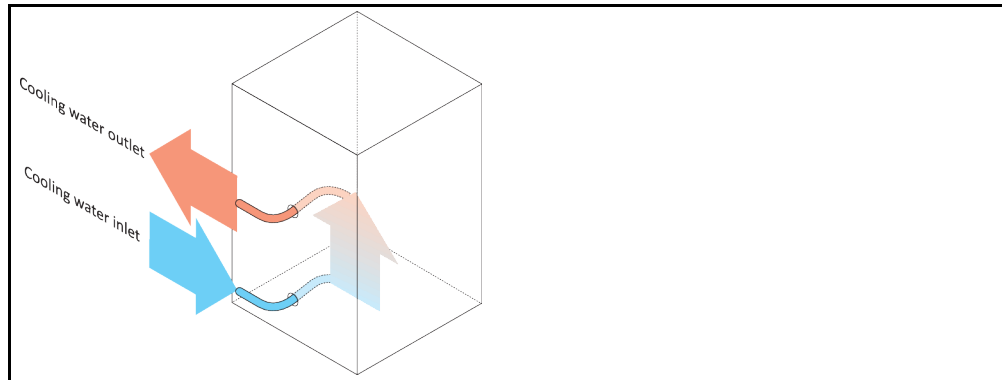

1.6.1 Consequence of inadequate energy dissipation

Room air/cooling water

Consequences of, for instance, contamination of the liquefier fins, inadequate clearance between temperature control unit to wall/bath wall, room air/cooling water too warm, cooling water differential pressure too low, suction strainer contamination: The refrigerant in the coolant circuit can no longer fully discharge the admitted energy to the room air/cooling water. Thus there is not sufficient liquefied refrigerant available, the condensation temperature and the energy consumption to rise.

Coolant circuit

Consequences of inadequate refrigerant quantity/rising condensation temperature: Not all the cooling capacity from the coolant circuit is available at the evaporator. This means reduced energy transmission from the thermal fluid circuit.

Thermal fluid circuit

Consequence of inadequate energy dissipation from the thermal fluid: The thermal fluid can only dissipate the energy from your application to a limited extent.

Application

Consequences of inadequate energy dissipation from the application: The energy created (exothermic) in the application can no longer be fully dissipated.

Temperature control unit

An electronically-controlled expansion valve is used in the temperature control unit to optimize the power adjustment. The expansion valve always provisions the maximum possible cooling capacity within the permissible ambient temperature range. The temperature control unit switches off when the upper range is reached (maximum permissible ambient temperature).

2 Commissioning

2.1 In-plant transport

WARNING

Temperature control unit is not transported / moved according to the specifications in this operation manual

DEATH OR SERIOUS INJURY DUE TO CRUSHING

- Always transport / move the temperature control unit according to the specifications in this operation manual.
- Wear personal protective equipment during transport.
- Always work with the specified number of persons when moving the temperature control unit on casters (if any).
- If the temperature control unit is equipped with casters and parking brakes: 2 parking brakes are always freely accessible when moving the temperature control unit. Activate the **2 parking brakes** in an emergency! If only **one** parking brake is activated on the casters in an emergency: The temperature control unit is not stopped but rotates around the axis of the caster with the activated parking brake!

NOTE

Temperature control unit transported in a horizontal position

DAMAGE TO THE COMPRESSOR

- Only transport the temperature control unit in an upright position.

NOTE

Filled temperature control unit is transported

MATERIAL DAMAGE DUE TO OVERFLOWING THERMAL FLUID

- Only transport an emptied temperature control unit.
- If available, use the lugs on the top side of the temperature control unit for transportation.
- Use an industrial truck for transport.
- The casters (if present) on the temperature control unit are not suitable for transport. The casters are symmetrically loaded with 25% of the total mass of the temperature control unit.
- Remove the packing material (e.g. the palette) only at the place of installation.
- Protect the temperature control unit from transport damage.
- Do not transport the temperature control unit alone and without aids.
- Check the load bearing capacity of the transportation route and the place of installation.
- The parking brakes at the casters (if any) must be activated and/or the leveling feet (if any) must be unscrewed/activated before the temperature control unit is put into operation. → Page 26, section »Unscrewing/activating the leveling feet (if any)«.

2.1.1 Lifting and transporting the temperature control unit

2.1.1.1 Temperature control unit with lifting eyes

NOTE

The temperature control unit is raised at the lifting eyes without load handling attachments

DAMAGE TO THE TEMPERATURE CONTROL UNIT

- Always use load handling attachments when lifting and transporting the temperature control unit.
- The lifting eyes are only designed for a load **without** inclination (0°).
- The load handling attachment used must be adequately dimensioned. Take the dimensions and weight of the temperature control unit into account.

Example: lifting eyes
(round, angular, and
recessed (left to right))

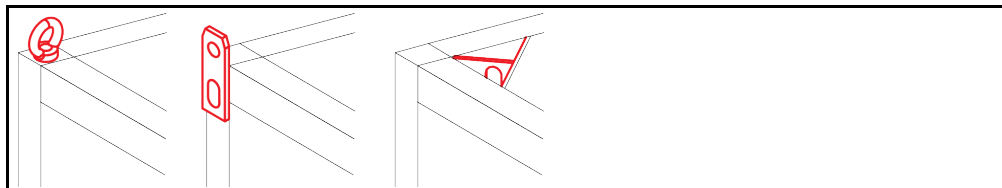

- Do not lift and transport the temperature control unit at the lifting eyes alone and without aids.
- Lift and transport the temperature control unit at the lifting eyes only with a crane or an industrial truck.
- The crane or industrial truck must have a lifting force equal to or greater than the weight of the temperature control unit. See the data sheet for the weight of the temperature control unit. → From page 50, section »Annex«.
- If the leveling feet have been removed for shipping: Only lower the temperature control unit when all leveling feet have been installed. → Page 22, section »Mounting/removing leveling feet«.

2.1.1.2 Temperature control unit without lifting eyes

Example: Supporting points for forklift arms for free-standing models from a certain overall size. For the exact position please refer to the wiring diagram in the annex.

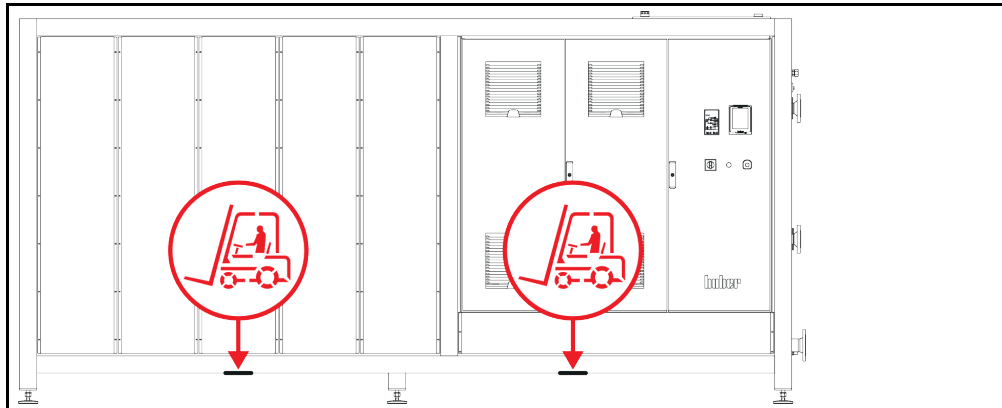

- Do not lift and transport the temperature control unit alone and without aids.
- Lift and transport the temperature control unit only with an industrial truck.
- The industrial truck must have a lifting force equal to or greater than the weight of the temperature control unit. See the data sheet for the weight of the temperature control unit. → From page 50, section »Annex«.
- If the leveling feet have been removed for shipping: Only lower the temperature control unit when all leveling feet have been installed. → Page 22, section »Mounting/removing leveling feet«.

2.1.2 Mounting/removing leveling feet

Only valid if the leveling feet have been removed for shipping.

WARNING

The temperature control unit is not secured against slipping and/or lowering
DEATH OR SERIOUS INJURY DUE TO CRUSHING

- Secure the temperature control unit against slipping and/or lowering before the leveling feet are mounted.
- Do not stand or lie under the temperature control unit for mounting.

Example: mounting the leveling feet

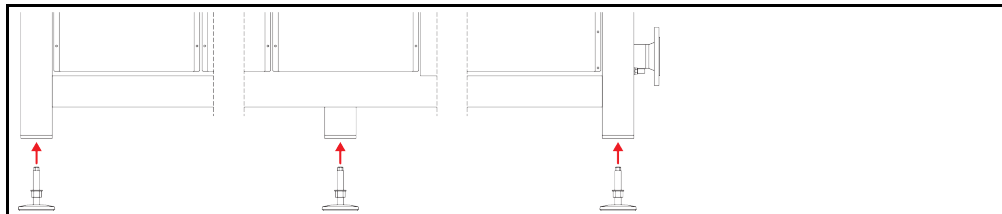

INFORMATION

The leveling feet were removed for shipping the temperature control unit. Before placing / positioning the temperature control unit all leveling feet must be mounted. If the temperature control unit is re-shipped: Remove all leveling feet before packaging.

- The leveling feet can only be mounted while the temperature control unit is lifted.
- Secure the temperature control unit against slipping and/or lowering.
- Do not stand or lie under the temperature control unit while mounting the leveling feet.
- Do not lower the temperature control unit until all leveling feet have been mounted.

2.1.3 Positioning the temperature control unit

2.1.3.1 Temperature control unit with casters

- Do **not** use the casters for the transportation to the place of installation. → Page 21, section »**Lifting and transporting the temperature control unit**«.
- Use the casters only for positioning at the place of installation.
- Only ever move the temperature control unit on the casters if the surface is level, without gradient, non-slip and stable.
- Do not move the temperature control unit alone.
- **At least 2 persons** are required to move the temperature control unit on casters. **At least 5 persons** are required to move the temperature control unit on the casters if the total weight of the temperature control unit is **over 1.5 tons**.
- The parking brakes must be activated at the casters and/or the feet (if present) must be unscrewed/activated before the temperature control unit is put into operation. → Page 26, section »**Unscrewing/activating the leveling feet (if any)**«.

2.1.3.2 Temperature control unit without casters

- An industrial truck must be used for positioning the temperature control unit.
- Do not move the temperature control unit alone.
- **At least 2 persons** are required to move the temperature control unit.
- The industrial truck must have a lifting force equal to or greater than the weight of the temperature control unit. See the data sheet for the weight of the temperature control unit. → From page 50, section »**Annex**«.
- The leveling feet (if present) must be unscrewed/activated before the temperature control unit is put into operation. → Page 26, section »**Unscrewing/activating the leveling feet (if any)**«.

2.2 Unpacking



WARNING

Starting up a damaged temperature control unit

DANGER TO LIFE FROM ELECTRIC SHOCK

- Do not operate a damaged temperature control unit.
- Please contact Customer Support. → Page 48, section »**Contact data**«.

PROCEDURE

- Check for damage to the packaging. Damage can indicate material damage to the temperature control unit.
- Check for any transport damage when unpacking the temperature control unit.
- Always contact your forwarding agent regarding the settlement of claims.
- Observe the proper disposal of packaging material. → Page 15, section »**Proper disposal of resources and consumables**«.

2.3 Ambient conditions



CAUTION

Unsuitable ambient conditions / unsuitable installation

SERIOUS INJURY DUE TO CRUSHING

- Comply with all requirements! → Page 23, section »**Ambient conditions**« and → Page 25, section »**Installation conditions**«.

INFORMATION

Make sure there is adequate fresh air available at the site for the circulation pump and the compressors. The warm exhaust air must be able to escape upwards unhindered.

Free-standing models

For the connection data, see the data sheet. → From page 50 in the section »**Annex**«.

Use of the temperature control unit is permitted only under normal ambient conditions in accordance with the currently valid DIN EN 61010-1.

- Use only indoors. The illuminance must be at least 300 lx.
- Installation altitude up to 2,000 meters above sea level.
- Maintain wall and ceiling clearance for adequate air exchange (dissipation of waste heat, supply of fresh air for the temperature control unit and work area). Ensure adequate floor clearance for air-cooled temperature control units. Do not operate this temperature control unit from within the box or with an inadequately dimensioned bath. This inhibits the air exchange.
- Ambient temperature values are provided on the technical data sheet; to ensure trouble-free operation, compliance with the ambient conditions is mandatory.
- Relative humidity max 80% to 32 °C and 40 °C decreasing linearly to 50%.
- Short distance to supply connections.
- The temperature control unit must not be installed so as to hinder or even prevent access to the disconnecting device (to the power supply).
- For the magnitude of the mains voltage fluctuations, refer to the datasheet. → From page 50, section »Annex«.
- Transient surges, as would normally occur in the power supply system.
- Installation Class 3
- Applicable degree of soiling: 2.
- Surge category II.

Please note: → Page 19, section »Exemplary illustrations of the cooling variants«.

Wall clearances		Clearance in cm	
Side			
	[A2] Top	free standing	
	[B] Left	min. 10	
	[C] Right	min. 10	
	[D] Front	min. 10	
	[E] Rear	min. 10	
Side			
	[A2] Top	free standing	
	[B] Left	min. 20	
	[C] Right	min. 20	
	[D] Front	min. 20	
	[E] Rear	min. 20	

2.3.1 EMC-specific notes

INFORMATION

Connecting cables in general

Prerequisites for a failure-free operation of the temperature control units incl. their connections with external applications: Installation and wiring must be carried out professionally. Related topics: "Electrical safety" and "EMC-compliant wiring".

Cable lengths

For flexible/fixed cable routing of more than 3 meters, the following must amongst other things be observed:

- Equipotential bonding, grounding (see also technical data sheet "Electromagnetic compatibility EMC")
- Compliance with "external" and/or "internal" lightning/overvoltage protection.
- Design protection measures, professional cable selection (UV resistance, steel pipe protection, etc.)

Attention:

The operating company is responsible for compliance with national/international directives and laws. This also includes the testing of the installation/wiring required by law or standards.

This device is suitable for operation in "industrial electromagnetic environments". It meets the "immunity requirements" of the currently applicable **EN61326-1**, which are required for this environment.

It also meets the "interference emission requirements" for this environment. It is a **Group 1** and **Class A** device according to the currently applicable **EN55011**.

Group 1 specifies that high frequency (HF) is only used for the function of the device. **Class A** defines the interference emission limits to be observed.

2.4 Installation conditions

WARNING

Temperature control unit is connected to the power supply line

DEATH FROM ELECTRICAL SHOCK BY DAMAGE TO THE POWER CABLE.

- Do not put temperature control unit on power cable.

CAUTION

Operating the temperature control unit fitted with casters without brakes activated

CRUSHING OF LIMBS

- Activate brakes on the casters.

- Allow the temperature control unit to acclimate for about 2 hours when changing from a cold to a warm environment (or vice versa). Do not turn on the temperature control unit before!
- Install upright, stable and tilt-resistant.
- Use a non-combustible, sealed foundation.
- Keep the environment clean: Prevent slip and trip hazards.
- Wheels, if installed, must be locked after installation!
- Spilled/leaked thermal fluid must be removed immediately. Observe the proper disposal of thermal fluid and aids. → Page 15, section »Proper disposal of resources and consumables«.
- Observe the floor load bearing capacity for large units.
- Observe the ambient conditions.

2.5 Recommended temperature control hoses

CAUTION

Use of unsuitable/defective hoses and/or hose connections

INJURIES

- Use appropriate hoses and/or hose connections.
- Check periodically for leaks and the quality of the hose and hose connections and take suitable measures (replace) as required.
- Isolate and protect temperature control hoses against contact/mechanical load.

CAUTION

Hot or cold thermal fluid and surfaces

BURNS TO LIMBS

- Avoid direct contact with the thermal fluids or the surfaces.
- Wear your personnel protective equipment (e.g. temperature-resistant safety gloves, safety goggles, safety footwear).

To connect applications, use only temperature control hoses that are compatible with the thermal fluid used. When selecting temperature control hoses, also pay attention to the temperature range in which the hoses are to be used.

- We recommend you use only temperature-insulated temperature control hoses with your temperature control unit. The responsible body is responsible for the insulation of connection valves.

2.6 Wrench sizes and torques

Note the wrench sizes that result for the pump connection on the temperature control unit. The following table lists the pump connections and the resulting wrench sizes, and torque values. A leak test must always be performed, and the connections tightened if necessary. The values of the maximum torque (see table) must **not** be exceeded.

Overview wrench sizes and torques	Connection	Sleeve nut wrench size	Connector wrench size	Recommended torques in Nm	Maximum torques in Nm
	M16x1	19	17	20	24
	M24x1.5	27	27	47	56
	M30x1.5	36	32	79	93
		36	36	79	93
	M38x1.5	46	46	130	153
	G-thread (flat-sealing)	Adapt the torque to the material of the flat seal used. First hand-tighten the temperature control hose. When using adapters, do not overtighten the G-thread on the pump connection when connecting a temperature control hose. When connecting a temperature control hose to the adapter piece, secure the G thread against overwinding.			

2.7 Preparations for operation

2.7.1 Unscrewing/activating the leveling feet (if any)

WARNING

**The leveling feet are not unscrewed/activated before switching on the temperature control unit
DEATH OR SERIOUS INJURY DUE TO CRUSHING**

- The parking brakes must be activated at the casters (if any) and/or the leveling feet must be unscrewed/activated before the temperature control unit is put into operation.
- The temperature control unit may move if the parking brakes of the casters (if any) are not activated and/or the leveling feet are not unscrewed/activated.

Always unscrew/activate the leveling feet before switching on the temperature control unit. Uneven floors can be compensated by adjusting these leveling feet.

PROCEDURE

- Verify that the parking brakes of the casters (if any) have been activated.
- Unscrew the leveling feet.
- Compensate uneven floors by adjusting these leveling feet, if necessary. Use a spirit level to horizontally align the temperature control unit.
- Tighten the lock screws on the leveling feet after aligning the temperature control unit. This prevents the leveling feet from changing their height during operation.

2.7.2 Opening/closing valves

Opening and closing valves



INFORMATION

Opening valves:

Open valves by turning them counterclockwise (turn 90° left as far as it will go).

Close valves:

close valves by turning them clockwise (turn 90° right as far as it will go).

PROCEDURE

- Check that all valves are closed.
- Close all valves by turning them clockwise (turn 90° right as far as it will go).

2.7.3 Installing collecting container

PROCEDURE

- Install a suitable hose at the **>overflow<** [12] on the temperature control unit (if present). The hose must be compatible with the thermal fluid and the temperature.
- Put the other end of the hose in a suitable collecting container.

2.7.4 Install additional work surface (optional)

Install additional work surface

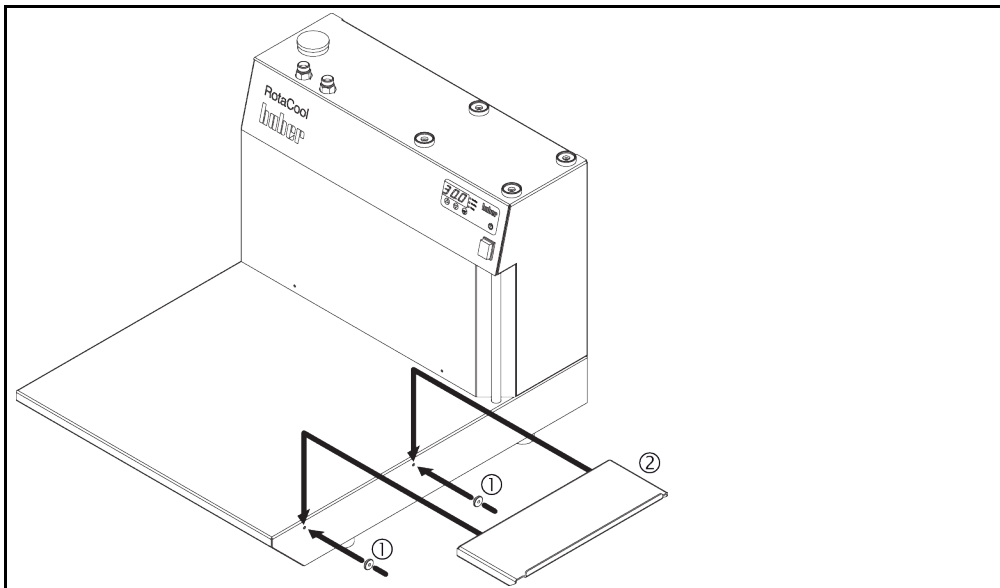

PROCEDURE

- First mount the two mounting brackets in the appropriate holes.
- Mount the additional work surface to the mounting brackets.

2.7.5 Connecting the functional earth

PROCEDURE

- If required, connect the temperature control unit's **>Functional ground terminal<** [87] to the building's grounding point. Use a ground strap for this purpose. For the exact position and thread size please refer to the wiring diagram. → From page 50, section »Annex«.

2.8 Connecting externally closed application

Observe the wiring diagram. → From page 50, section »Annex«.

2.8.1 Connecting an externally closed application

NOTE

Overpressure in the application (e.g. > 0.5 bar (g) with glass apparatus)

MATERIAL DAMAGE TO THE APPLICATION

- Provide an overpressure protective device to prevent damage to the application.
- Do not install valves/quick-release couplings in the feed/discharge lines from the temperature control unit to the application and from the application to the temperature control unit.
- **If valves/quick-release couplings are required:**
- Install burst disks on the application itself (at the feed and discharge lines).
- Install a bypass upstream of the valves/quick-release couplings for the application.
- Matching accessories (e.g. bypasses to reduce pressure) can be found in the Huber catalog.

Example: Connecting an externally closed application

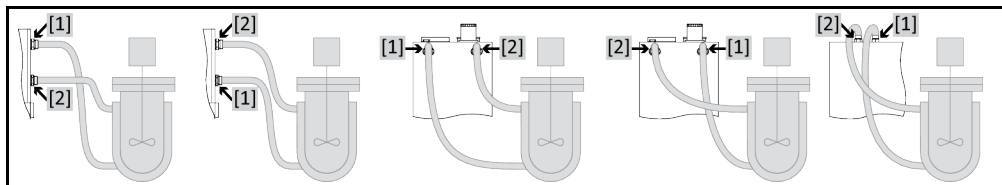

To enable your application to be operated correctly and eliminate air bubbles from the system, you must ensure that the >Circulation flow< [1] connection from the temperature control unit is attached to the lower connection point of the application and the >Circulation return< [2] into the temperature control unit is attached to the higher connection point of the application.

PROCEDURE

- Remove the screw plugs from the >Circulation flow< [1] and >Circulation return< [2] connections.
- Then connect your application to the temperature control unit using suitable thermal fluid hoses. Observe the table with the wrench sizes. → Page 26, section »Wrench sizes and torques«.
- Check the connections for leaks.

2.9 Connecting to the power supply

INFORMATION

Based on local circumstances, it may be that you need to use an alternative power cable instead of the supplied original power cable. Do not use a power cable that is longer than **3 m** to be able to disconnect the temperature control unit at any time from the mains. Have the mains cable only replaced by a qualified electrician.

2.9.1 Connection using socket with protective earth (PE)

DANGER

Connecting to a power socket without protective earth (PE)

MORTAL DANGER FROM ELECTRIC SHOCK

- Always connect the temperature control unit to safety sockets (PE).

DANGER

Damaged power cable/power cable connection

MORTAL DANGER FROM ELECTRIC SHOCK

- Do not start up the temperature control unit.
- Isolate the temperature control unit from the power supply.
- Have the power supply cable/power supply connection replaced and inspected by an electrician.
- Do not use a power cable that is longer than **3 m**.

NOTE**Incorrect power supply connection****DAMAGE TO THE TEMPERATURE CONTROL UNIT**

- Your building's existing power supply voltage and frequency must match the data provided on the rating plate of the temperature control unit.

INFORMATION

In case of uncertainties about an existing protective earth (PE), have the connection inspected by an electrician.

2.9.2 Connection via hard wiring

 DANGER**Connection/adjustment to the power supply not carried out by an electrician****MORTAL DANGER FROM ELECTRIC SHOCK**

- Have the connection/adjustment to the power supply carried out by an electrician.

 DANGER**Damaged power cable/power cable connection****MORTAL DANGER FROM ELECTRIC SHOCK**

- Do not start up the temperature control unit.
- Isolate the temperature control unit from the power supply.
- Have the power supply cable/power supply connection replaced and inspected by an electrician.
- Do not use a power cable that is longer than **3 m**.

NOTE**Incorrect power supply connection****DAMAGE TO THE TEMPERATURE CONTROL UNIT**

- Your building's existing power supply voltage and frequency must match the data provided on the rating plate of the temperature control unit.

3 Function description

3.1 Function description of the temperature control unit

3.1.1 General functions

This temperature control unit is designed for **externally closed applications**. → Page 28, section »Connecting an externally closed application«.

Circulating coolers are temperature control units, which are mainly used to dissipate process heat as well as a cost effective alternative to cooling water (drinking water).

A rotary evaporator and a vacuum pump can be placed on top of the temperature control unit to save space.

Due to **powerful refrigeration engineering**, **short cooling rates** can be achieved.

3.1.2 Other functions

A pump ensures good circulation of the thermal fluid. The **LED display** shows the current temperature. A new setpoint can be easily entered with a simple keyboard.

3.2 Information on the thermal fluids

CAUTION

Non-compliance with the safety data sheet for the thermal fluid to be used

INJURIES

- Risk of injury to the eyes, skin, respiratory tract.
- The safety data sheet for the thermal fluid to be used must be read prior to using it and its content must be respected.
- Observe the local regulations/work instructions.
- Wear your personal protective equipment (e.g. temperature-resistant safety gloves, safety goggles, safety footwear).
- Danger of slipping because floor and work area are contaminated. Clean the workplace; observe the proper disposal of thermal fluid and aids. → Page 15, section »Proper disposal of resources and consumables«.

NOTE

Non-compliance with the compatibility between the thermal fluid and your temperature control unit

MATERIAL DAMAGE

- Observe the classification of your temperature control unit according to DIN 12876.
- Ensure the following materials are resistant with respect to the thermal fluid: Stainless steel 1.4301/ 1.4401 (V2A), copper, nickel, FKM, red bronze/brass and silver solder.
- The maximum viscosity of the thermal fluid must not exceed 50 mm²/s at the lowest working temperature!
- The maximum density of the thermal fluid may not exceed 1 kg/dm³!

NOTE

Mixing different thermofluids in a thermal fluid circuit

PROPERTY DAMAGE

- Do **not** mix different types of thermofluid (such as mineral oil, silicone oil, synthetic oil, water, etc.) in a thermofluid circuit.
- The thermal fluid circuit **must** be rinsed when changing from one type of thermal fluid to another. No residues of the previous type of thermal fluid may remain in the thermal fluid circuit.

Thermal fluid: Water

Designation	Specification
Calcium carbonate per liter	≤ 1.5 mmol/l; corresponds to a water hardness of: ≤ 8.4 °dH (soft)
pH value	between 6.0 and 8.5
Ultrapure water, distillates	Add 0.1 g of sodium carbonate (Na ₂ CO ₃) per liter
Not approved water	Distilled, deionized, demineralized, chloric, ferruginous, ammoniacal, contaminated or untreated river water or sea water
Volume circulated (at least)	3 l/min.
Thermal fluid: Water without ethylene glycol	
Use	≥ +3 °C
Thermal fluid: Water-ethylene glycol mixture	
Use	< +3 °C
Thermal fluid composition	The mixture's temperature must be 10 K below the permissible min. temperature. For the permissible temperature range, refer to the datasheet. → From page 50, section »Annex«.

3.3 To be noted when planning the test

INFORMATION

Observe the intended operation. → Page 14, section »Proper operation«.

The focus is on your application. Bear in mind that system performance is influenced by heat transfer, temperature, thermal fluid viscosity, volume flow, and flow speed.

- Make sure the electrical connection is adequately dimensioned.
- The installation location of the temperature control unit should be selected so as to ensure adequate fresh air, even with water-cooled chillers.
- The maximum flow pressure of a temperature control unit must be taken into account in case of pressure-sensitive applications, such as glass reactors.
- Cross-section reduction or shut-off in the thermal fluid circuit must be avoided. Take appropriate measures to limit the pressure in the system. Observe the data sheet of your glass apparatus and the data sheet of your temperature control unit. → From page 50, section »Annex«.
- Check whether it is necessary to use an external bypass for temperature control units without pressure limitation.
- In order to prevent the risk of overpressure in the system, the thermal fluid must always be adjusted to room temperature before switching off. This will prevent damage to the temperature control unit or the application. Any isolating valves must remain open (pressure equalization).
- Select the thermal fluid to be used in such a way that it not only permits the minimum and maximum working temperature but is also suitable with regard to fire point, boiling point, and viscosity. In addition, the thermal fluid must be compatible with all the materials in your system.
- Avoid bending the temperature control and cooling water hoses (if required). Use suitable angle pieces and lay the hose connections with a large radius. Take the minimum bending radius from the data sheet of the temperature control hoses used.
- The selected hose connections must be able to withstand the thermal fluid, the working temperatures and the admissible maximum pressure.
- Check the hoses at regular intervals for any material fatigue (e.g. cracks, leaks).
- Keep the temperature control hoses as short as possible
 - The inside diameters of the temperature control hoses must correspond at least to the pump connections. Select bigger inside diameters for longer line lengths to compensate for pressure loss in the piping.
 - The viscosity of the thermal fluid determines the pressure drop and influences the temperature control result, especially at low working temperatures.
 - Too small connectors and couplers and valves can generate significant flow resistance. Your application will therefore be slower to reach its design temperature.
- Basically, you should only use the thermal fluid recommended by the manufacturer and only within the usable temperature and pressure range.

- The application should be roughly at the same height of or below the temperature control unit if the temperature control is close to the boiling temperature of the thermal fluid.
- Fill the temperature control unit slowly, carefully and evenly. Wear the necessary personal protective equipment, such as goggles, heat-proof and chemically resistant gloves, etc.
- The temperature control circuit must be vented after filling and setting all required parameters. This is required to ensure trouble-free operation of the temperature control unit and hence your application.

INFORMATION

For water-cooled temperature control units, please take the cooling water temperature necessary for perfect operation and the required differential pressure from the data sheet. → From page 50, section »Annex«.

3.4 Display and control instruments

The control panel:
Displays and keys

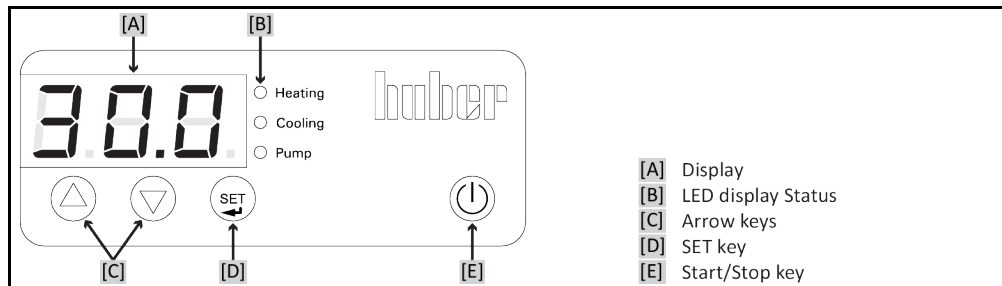

3.4.1 Display

The value of the internal temperature is displayed. For example, this is the bath temperature for temperature control units with a bath, or the flow temperature of chillers. Different key combinations also display the setpoint, a menu item or settings.

3.4.2 LED display status

These LEDs indicate the current operating condition.

3.4.3 Arrow keys

These keys are used to (▲)increase or decrease (▼) the setpoint or select or change a menu item. The >Arrow keys< [C] are also required to call the menu up.

3.4.4 SET key

The >SET key< [D] is used to switch to the setpoint temperature. It is used to display and modify the setpoint temperature. The >SET key< [D] is also used to display the values of the various menu items.

3.4.5 Start/Stop key

This key starts or stops the thermoregulation.

3.5 Menu function

Your temperature control unit is equipped with a menu function.

Overview of the menu items

Menu item	Display	Description
ADR		Without a function
C40		Auto-Start function
PA		Service menu Only for Huber service personnel.
--		

3.6 Function examples

3.6.1 Display setpoint

PROCEDURE

- Press the >SET key< [D] and keep it pressed. The setpoint is displayed.
- Release the >SET key< [D]. The internal temperature is displayed again.

3.6.2 Set/change setpoint

PROCEDURE

- Press the >SET key< [D] and keep it pressed. The setpoint is displayed.
- Use the >Arrow keys< [C] to select the required value.
 - ⊕ (up) the temperature increases, ⊖ (down) the temperature decreases.
- Release the >SET key< [D]. The new setpoint is set.

3.6.3 Changing the Auto-Start function

Following a power outage (or when switching on the temperature control unit), this function can be used to determine how the temperature control unit is supposed to respond.

Auto-Start function is turned off

The temperature control is started only by manual input when the temperature control unit is turned on.

Auto-Start function is turned on

The temperature control unit is set to the same state it was in before the power outage. For example, before the power outage: Thermoregulation is off; after power outage: Thermoregulation is off. If temperature control is active during a power outage, the process will automatically continue after the power outage.

Settings in the menu item "C40" auto-start function

Setting	Display	Description
0		The auto-start function is turned on.
1		The auto-start function is turned off.

PROCEDURE

- Press the **>Arrow keys** < [C] ⬆ and ⬇ simultaneously for 3 seconds. The display changes from the display of the temperature to the display of the first menu item.
- Press the **>Arrow key** < [C] ⬇ until the menu item "C40" is displayed.
- Press the **>SET key** < [D] and keep it pressed.
- Press the **>SET key** < [D] and simultaneously the **>Arrow keys** < [C] ⬆ and ⬇. The display changes from "0" (auto-start function is ON) to "1" (auto-start function is OFF). Release the **>SET key** < [D] after the required setting was made.
- Press the **>Arrow keys** < [C] ⬆ and ⬇ simultaneously for 1 second. Or wait a few seconds after releasing the **>SET key** < [D]. The selected function is saved and menu is exited. The display shows the temperature again.

4 Setup mode

4.1 Setup mode

CAUTION

Moving the temperature control unit during operation
SERIOUS BURNS/FREEZING OF THE HOUSING PARTS/ESCAPING THERMAL FLUID
 ➤ Do not move temperature control units that are in operation.

4.1.1 Turning on the temperature control unit

PROCEDURE

- Switch on the temperature control unit using the >Mains switch< [37]. Circulation and thermoregulation are turned off.

4.1.2 Turning off the temperature control unit

PROCEDURE

- Warm the thermofluid to room temperature.
- Stop the thermoregulation.
- Switch off the temperature control unit using the >Mains switch< [37].

4.1.3 Setting the setpoint

PROCEDURE

- Switch on the temperature control unit.
- Press and hold the >SET key< [D]. The setpoint is displayed.
- Use the >Arrow keys< [C] to select the required value.
- ⤴ (up) the temperature value is increased, ⤵ (down) the temperature value is decreased.
- Release the >SET key< [D]. The new setpoint is set.

4.2 Filling, venting and draining

Observe the wiring diagram. → From page 50, section »Annex«.

CAUTION

Extremely hot / cold surfaces, connections and thermal fluids
BURNS/FREEZING OF LIMBS

- Surfaces, connections and tempered thermal fluids can be extremely hot or cold depending on the operating mode.
- Avoid direct contact with surfaces, connections and thermal fluids!
- Wear your personnel protective equipment (e.g. temperature-resistant safety gloves, safety goggles).

NOTE

During an active circulation, the thermal fluid circuit is shut off by shut-off valves
MATERIAL DAMAGE TO THE CIRCULATING PUMPS INSTALLED IN THE TEMPERATURE CONTROL UNIT
 ➤ Do not close the thermal fluid circuit during an active circulation by means of shut-off valves.
 ➤ Warm the thermal fluid to room temperature before stopping the circulation.

4.2.1 Filling and venting externally closed application

CAUTION

Non-compliance with the safety data sheet for the thermal fluid to be used

INJURIES

- Risk of injury to the eyes, skin, respiratory tract.
- The safety data sheet for the thermal fluid to be used must be read prior to using it and its content must be respected.
- Observe the local regulations/work instructions.
- Wear your personal protective equipment (e.g. temperature-resistant safety gloves, safety goggles, safety footwear).
- Danger of slipping because floor and work area are contaminated. Clean the workplace; observe the proper disposal of thermal fluid and aids. → Page 15, section »Proper disposal of resources and consumables«.

NOTE

Semi-automatic venting

DAMAGE TO THE TEMPERATURE CONTROL UNIT

- An elevated tolerance time for the pressure drop can damage the pump if the thermal fluid level in the system is also too low.
- Constantly observe the thermal fluid level on the >Level indicator/Level< [25]. Fill up the thermal fluid during the venting phase so the thermal fluid level does not fall below the minimum mark.

INFORMATION

Calculate whether the capacity of the >Expansion vessel< [18] can absorb the expansion volume during operation. Assume the following volumes for this calculation: [Minimum filling capacity of the temperature control unit] + [Volume of the thermal fluid hoses] + [Jacket volume of your application] + [10% / 100 K].

Fill levels in the >Level indicator/Level< [25]



- During the fill process, ensure any necessary measures, such as earthing the tanks, funnels and other aids, have been taken.
- Fill to the lowest possible height.

PROCEDURE

- Ensure that a hose was installed at the >Overflow< [12] (if installed). The other end of the hose must be inserted in a suitable collecting container. Excess thermal fluid will leak at this point when the temperature control unit is overfilled. Hose and container must be resistant to the thermal fluid and the temperature.
- Manually open the >Filling port< [17].
- Carefully pour suitable thermal fluid, using the filling accessories (funnel and/or beaker) into the >Filling port< [17]. The thermal fluid flows into the temperature control unit and through the hose connections to the external application. The fill levels are displayed in the >Level indicator/Level< [25]. Follow the instructions for the proper disposal when cleaning filling accessories. → Page 15, section »Proper disposal of resources and consumables«.
- Switch on the temperature control unit.
- Set the setpoint to 20 °C. → Page 33, section »Set/change setpoint«.

- Start the circulation by pressing the **>Start/Stop button<** [E].
- Refill thermal fluid. Observe the fill level in the **>Level indicator/Level<** [25]. The filling/venting process is complete when the thermal fluid is 1 cm below the max. mark of the **>Level indicator/Level<** [25].

INFORMATION

If, with externally closed applications (reactors), the fluid level in the fill level display remains the same when the pump is running and when the pump has stopped, the application has been vented.

- Stop the circulation by pressing the **>Start/Stop button<** [E].
- Switch off the temperature control unit.
- Manually close the **>Filling port<** [17].
- Check the level of the collecting container at regular intervals. Empty the container when necessary and dispose of its contents properly.
- Manually close the **>Filling port<** [17].
The temperature control unit is now filled.

INFORMATION

Venting must be performed especially during commissioning and after a change of thermal fluid. This is the only way to ensure trouble-free operation.

Note that the volume expansion of the thermal fluid depends on the working temperature range you wish to work in. At the "lowest" working temperature, do not go below the **minimum** mark of the **>Level indicator/Level<** [25] and at the "highest" working temperature, do not go above the maximum mark. In case of overfilling, drain the excess amount of thermal fluid. → Page 37, section **»Draining externally closed applications«**. Check if the thermal fluid can be reused. Follow the instructions for the proper disposal. → Page 15, section **»Proper disposal of resources and consumables«**.

4.2.2 Draining externally closed applications

 **CAUTION**

Hot or very cold thermal fluid

SEVERE BURNS/FROSTBITE OF LIMBS

- Before draining, ensure that the thermal fluid has room temperature (20 °C).
- If, at this temperature, the thermal fluid is too viscous to be drained: Control the temperature of the thermal fluid for a few minutes until the viscosity will allow drainage. Never control the temperature of the thermal fluid when the drain is open.
- Danger of burns when draining thermal fluids at temperatures above 20 °C.
- Wear your Personal Protective Equipment for draining.
- Only drain using suitable drainage hose and collecting container. These must be compatible with the thermal fluid and its temperature.

PROCEDURE

Temperature control units with **>Drain valve thermal fluid<** [3].

- Remove the knurled screw at the **>Drain<** [8].
- Connect a suitable drain hose to the **>Drain<** [8].
- Place the other end of the hose in a suitable container.
- Open the **>Drain valve thermal fluid<** [3] by turning it counterclockwise (turn 90° left as far as it will go). The thermal fluid will flow from the external application via the temperature control unit and the draining hose into the container. Check if the thermal fluid can be reused. Follow the instructions for the proper disposal. → Page 15, section **»Proper disposal of resources and consumables«**.
- Wait until the external application and the temperature control unit are empty.
- Open the connection **>Circulation flow<** [1].
- Open the connection **>Circulation return<** [2].
- Leave the temperature control unit open for a while to allow it to dry out and the residue to drain. Without screw caps and with **>Drain valve thermal fluid<** [3] open.
- Close the **>Drain valve thermal fluid<** [3] by turning it clockwise (turn 90° right as far as it will go).
- Close the connection **>Circulation flow<** [1].
- Close the connection **>Circulation return<** [2].
- After drying out, remove the drain hose and re-fit the knurled screw to the **>Drain<** [8]. The temperature control unit is now drained.

5 Normal operation

5.1 Automatic operation

CAUTION

Extremely hot / cold surfaces, connections and thermal fluids

BURNS/FREEZING OF LIMBS

- Surfaces, connections and tempered thermal fluids can be extremely hot or cold depending on the operating mode.
- Avoid direct contact with surfaces, connections and thermal fluids!
- Wear your personnel protective equipment (e.g. temperature-resistant safety gloves, safety goggles).

NOTE

During an active circulation, the thermal fluid circuit is shut off by shut-off valves

MATERIAL DAMAGE TO THE CIRCULATING PUMPS INSTALLED IN THE TEMPERATURE CONTROL UNIT

- Do not close the thermal fluid circuit during an active circulation by means of shut-off valves.
- Warm the thermal fluid to room temperature before stopping the circulation.

5.1.1 Temperature control

5.1.1.1 Starting the temperature control process

The temperature control process can be started after filling and complete venting.

PROCEDURE

- With the temperature control unit switched on and thermoregulation/circulation stopped, press the **>Start/Stop button<** [E]. Thermoregulation starts.

5.1.1.2 Ending the temperature control process

NOTE

When the temperature control unit is switched off, the thermal fluid temperature is higher/lower than room temperature

DAMAGE TO THE TEMPERATURE CONTROL UNIT AND THE GLASS APPARATUS/APPLICATION

- Bring the thermal fluid up to room temperature using the temperature control unit.
- Do not close the shut-off valves in the thermal fluid circuit.

Thermoregulation can be terminated at any time. Thermoregulation and circulation are switched off immediately afterwards.

PROCEDURE









- With the temperature control unit switched on and thermoregulation/circulation started, press the **>Start/Stop button<** [E]. Thermoregulation stops.

6 Service/maintenance

6.1 Displays in the event of faults

The device displays an alarm or warning message in the event of a fault.

Overview of messages

Display	Cause	Effect, measure
 F1 - flashing	Error Sensor1 Break or short circuit	Control is inactive. (Pump off, compressor off, heating off) Check the sensor.
 E1 - flashing	Input E1 reports an error - no enable signal, level alarm	Control is inactive. (Pump off, compressor off, heating off) Check level. Restart only possible when level OK.
 E2 - flashing	Input E1 reports error. Pump runs and no flow or pump is running and no water pressure.	Control is inactive. (Pump off, compressor off, heating off) Restart only possible by interrupting the power supply.
 E3 - flashing	Although the control is off, the input E1 signals a flow	Control is inactive. (Pump off, compressor off, heating off) The error is corrected automatically when input E1 is open in standby again.
 EP - flashing  EPO - flashing  EP1 - flashing	Loss of data in the parameter memory	Control is inactive. (Pump off, compressor off, heating off) Please contact Customer Support. → Page 48, section » Contact data «.
 H2O flashing	No thermal fluid or too little thermal fluid	Temperature control unit can not be started. Add thermal fluid or fill the temperature control unit properly.

INFORMATION

During the output of the error message, the error message and the actual value are displayed alternately.

6.2 Maintenance



Cleaning/maintenance while the temperature control unit is operating

MORTAL DANGER FROM ELECTRIC SHOCK

- Stop an ongoing temperature control process.
- Turn off the temperature control unit.
- Also disconnect the temperature control unit from the power supply.

NOTE
Performing maintenance work not described in these operation manual
MATERIAL DAMAGE ON THE TEMPERATURE CONTROL UNIT

- Please contact Huber for maintenance work that is not described in these operation manual.
- Maintenance work not described in these operation manual is reserved for qualified specialists trained by Huber.
- Safety-relevant components may only be replaced by equivalent ones. The specified safety values for the respective component must be observed.

6.2.1 Function check and visual inspection

Control intervals

Cooling*	Description	Maintenance interval	Comment	Person responsible
A/W	Visually inspect hoses and hose connections	Prior to switching on the temperature control unit	Exchange leaking hoses and hose connections prior to switching on the temperature control unit. → Page 41, section » Replacing temperature control hoses «.	Operating company and / or operators
A/W	Check the fill level in the collecting container at the >Overflow< [12] (if present)	Prior to switching on the temperature control unit	Check the fill level in the collecting container. Empty as required. Follow the instructions for the proper disposal of thermal fluid. → Page 15, section » Proper disposal of resources and consumables «.	Operating company and / or operators
A/W	Inspection in accordance with the F-Gas Directive	In accordance with the F-Gas Directive	→ Page 17, section » Temperature control units with fluorinated greenhouse gases/refrigerants «.	Operating company
A/W	Check the power supply cable	Prior to switching on the temperature control unit or on relocation	Do not start the temperature control unit if the power supply cable is damaged.	Qualified electrician (BGV A3)
A	Clean the perforated sheet	As required	Clean the perforated sheet of the temperature control unit with a damp cloth	Operating company
A/W	Thermal fluid inspection	As required		Operating company and / or operators
A/W	Check the mechanical seals	Monthly	→ Page 44, section » Inspect the mechanical seal «.	Operating company and / or operators
A	Check the liquefier fins	As required, after 3 months at the latest	→ Page 41, section » Clean liquefier fins (air-cooled temperature control unit) «.	Operating company and / or operators
A/W	Check the temperature control unit for damage and stability	Every 12 months or after a change of location		Operating company and / or operators
W	Check the cooling water quality	Every 12 months	Descale the cooling water circuit as required. Documentation on water quality is available at: www.huber-online.com	Operating company and / or operators
A/W	Exchange safety-relevant electric and electromechanical components	20 years	Have the exchange only carried out by certified personnel (such as Huber service engineers). Please contact Customer Support. → Page 48, section » Contact data «.	Operating company

*A = Air cooling; W = Water cooling; U = Applicable only for Unistats

6.2.2 Replacing temperature control hoses

Replace defective temperature control hoses **before** turning on the temperature control unit.

PROCEDURE

- Drain the temperature control unit. → Page 37, section »**Draining externally closed applications**«.
- Replace defective temperature control hoses. Observe the proper disposal. → Page 15, section »**Proper disposal of resources and consumables**«.
- Reconnect your external application. → Page 28, section »**Connecting externally closed application**«.
- Fill the temperature control unit with thermal fluid. → Page 36, section »**Filling and venting externally closed application**«.
- Vent the temperature control unit. → Page 36, section »**Filling and venting externally closed application**«.
- Restart the temperature control unit in normal mode.

6.2.3 Clean liquefier fins (air-cooled temperature control unit)

CAUTION

Manual cleaning

RISK OF BEING CUT ON THE LIQUEFIER FINS

- Wear suitable cut-resistant gloves for cleaning work.
- Depending on the ambient conditions, use cleaning equipment such as vacuum cleaners and/or a hand brush/brush. Follow the local regulations when cleaning. Do not clean the liquefier fins in a clean room with items like a brush and do not use a vacuum cleaner without an extra-fine particle filter.

NOTE

Cleaning using pointed or sharp-edged tools

DAMAGE TO THE LIQUEFIER FINS

- Clean the liquefier fins using suitable cleaning appliances.

INFORMATION

Make sure there is adequate ventilation (removal of waste heat, fresh air supply) for the temperature control unit, in case of **air cooling, maintain wall clearance**. → Page 19, section »**Exemplary illustrations of the cooling variants**« and → Page 23, section »**Ambient conditions**«.
The liquefier fins must be cleaned (dust) from time to time as only then will the temperature control unit perform at its maximum cooling capacity.

The grille is located at the bottom of your temperature control unit.

PROCEDURE

Ventilation grille on the underside (table-top units)

NOTE

Cleaning of liquefier fins at the underside when the temperature control unit is filled

DAMAGE CAUSED BY THERMAL FLUID PENETRATING THE TEMPERATURE CONTROL UNIT

- Empty the temperature control unit before cleaning the liquefier fins at the underside of the temperature control unit.
- Switch off the temperature control unit.
- Disconnect the temperature control unit from the power supply.
- Drain the thermal fluid from the temperature control unit. → Page 37, section »**Draining externally closed applications**«.
- Tilt the temperature control unit to remove the grille (if available) in front of the liquefier fins.
- Clean the liquefier fins using suitable cleaning appliances. Observe the local regulations and ambient conditions when selecting cleaning appliances.
- Make sure the liquefier fins are not damaged or deformed as this will impair the air flow.
- Re-mount the ventilation grille after cleaning work.
- Connect the temperature control unit to the power supply.
- Refill the temperature control unit with thermal fluid. → Page 36, section »**Filling and venting externally closed application**«.

6.3 Thermal fluid inspection, replacement and circuit cleaning

Observe the wiring diagram. → From page 50, section »Annex«.

CAUTION

Extremely hot / cold surfaces, connections and thermal fluids

BURNS/FREEZING OF LIMBS

- Surfaces, connections and tempered thermal fluids can be extremely hot or cold depending on the operating mode.
- Avoid direct contact with surfaces, connections and thermal fluids!
- Wear your personnel protective equipment (e.g. temperature-resistant safety gloves, safety goggles).

NOTE

During an active circulation, the thermal fluid circuit is shut off by shut-off valves

MATERIAL DAMAGE TO THE CIRCULATING PUMPS INSTALLED IN THE TEMPERATURE CONTROL UNIT

- Do not close the thermal fluid circuit during an active circulation by means of shut-off valves.
- Warm the thermal fluid to room temperature before stopping the circulation.

6.3.1 Thermal fluid replacement

NOTE

Mixing different thermofluids in a thermal fluid circuit

PROPERTY DAMAGE

- Do **not** mix different types of thermofluid (such as mineral oil, silicone oil, synthetic oil, water, etc.) in a thermofluid circuit.
- The thermal fluid circuit **must** be rinsed when changing from one type of thermal fluid to another. No residues of the previous type of thermal fluid may remain in the thermal fluid circuit.

6.3.1.1 Externally closed application

Observe the following when replacing the thermal fluid: → Page 35, section »Filling, venting and draining«. The draining and filling operations are described in this section.

6.3.2 Rinsing the thermal fluid circuit

DANGER

Setpoint is not adjusted to the thermofluid

MORTAL DANGER FROM FIRE

- The setpoint set during rinsing **must** be adjusted to the thermofluid used.

CAUTION

Non-compliance with the safety data sheet for the thermal fluid to be used

INJURIES

- Risk of injury to the eyes, skin, respiratory tract.
- The safety data sheet for the thermal fluid to be used must be read prior to using it and its content must be respected.
- Observe the local regulations/work instructions.
- Wear your personal protective equipment (e.g. temperature-resistant safety gloves, safety goggles, safety footwear).
- Danger of slipping because floor and work area are contaminated. Clean the workplace; observe the proper disposal of thermal fluid and aids. → Page 15, section »Proper disposal of resources and consumables«.

NOTE

Mixing different thermofluids in a thermal fluid circuit

PROPERTY DAMAGE

- Do **not** mix different types of thermofluid (such as mineral oil, silicone oil, synthetic oil, water, etc.) in a thermofluid circuit.
- The thermal fluid circuit **must** be rinsed when changing from one type of thermal fluid to another. No residues of the previous type of thermal fluid may remain in the thermal fluid circuit.

Example: Connecting a short circuit hose

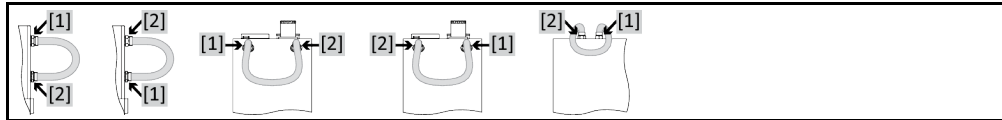

The inner components of the temperature control unit must be dried out. Need to avoid boiling retardation during future uses (e.g. use of a silicone oil at temperatures above about 100 °C).

PROCEDURE

- Drain the temperature control unit. → Page 37, section »**Draining externally closed applications**«.

INFORMATION

Residual thermal fluid can remain in the pump chamber and the internal lines after draining. Leave the temperature control unit with open valves for a while.

- Leave the drain hose mounted to the >Drain< [8].
- Check the fill level in the collecting container at the other end of the drain hose. Follow the instructions for the proper disposal of thermal fluid. → Page 15, section »**Proper disposal of resources and consumables**«.
- Close the drain valves on the temperature control unit by turning them clockwise (turn 90° right as far as they will go).
- Connect the >Circulation flow< [1] with the >Circulation return< [2] at the temperature control using a bypass hose.

INFORMATION

Perform the following steps without attaching a short circuit hose, if the application used by you (externally closed) is also dirty. In this case, leave your externally closed application connected to the temperature control unit. This rinses the temperature control unit and your application at the same time.

- **Fill** the system (minimum fill level) with the thermal fluid you wish to use. → Page 36, section »**Filling and venting externally closed application**«.
- **Vent** the system. → Page 36, section »**Filling and venting externally closed application**«.
- Adjust the **setpoint** to the thermal fluid used. → Page 33, section »**Set/change setpoint**«.
- **Start** the **circulation**. The length of rinsing depends on the level of soiling.
- **Stop** the **circulation**.
- **Drain** the temperature control unit. → Page 37, section »**Draining externally closed applications**«.
- Repeat the steps "Filling", "Venting", "Start/Stop circulation" and "Draining" until the drained thermal fluid remains clear.
- Remove the bypass hose after completely draining the temperature control unit.

INFORMATION

Leave an application connected, if you have simultaneously rinsed a used application (externally closed).

- Leave the >Drain< [8] open for a while to allow the thermal fluid remaining in the temperature control unit to evaporate.
- Close the >Drain< [8] once the residual thermal fluid has evaporated.
- Dismount the drain hose.
- Remove the collecting container.
- Discard the collecting container, including its contents, properly. Follow the instructions for the proper disposal. → Page 15, section »**Proper disposal of resources and consumables**«.
- Re-connect your application. (Only if you have rinsed the thermal fluid circuit using a bypass hose.)
- Fill the temperature control unit with thermal fluid. → Page 36, section »**Filling and venting externally closed application**«.
- Vent the temperature control unit. → Page 36, section »**Filling and venting externally closed application**«. An externally open application does not need to be vented.
- Restart the temperature control unit in normal mode.

6.4 Cleaning the surfaces

CAUTION

Extremely hot / cold surfaces, connections and thermal fluids

BURNS/FREEZING OF LIMBS

- Surfaces, connections and tempered thermal fluids can be extremely hot or cold depending on the operating mode.
- Avoid direct contact with surfaces, connections and thermal fluids!
- Wear your personnel protective equipment (e.g. temperature-resistant safety gloves, safety goggles).

NOTE

Exposed plug contacts

DAMAGE CAUSED BY FLUID INGRESS

- Protect unused plug contacts with the protective caps supplied.
- Clean surfaces only with a damp cloth.

A standard stainless steel cleaning agent is suitable for cleaning the stainless steel surfaces. Carefully clean painted surfaces (damp only) using a solution of sensitive-fabrics detergent. Observe the proper disposal of thermal fluid and aids. → Page 15, section »**Proper disposal of resources and consumables**«.

6.5 Inspect the mechanical seal

NOTE

No visual inspection of the mechanical seal

MATERIAL DAMAGE IN THE TEMPERATURE CONTROL UNIT CAUSED BY LEAKING MECHANICAL SEAL

- Check the mechanical seal once a month.
- If case of leakage, stop the temperature control unit and contact Customer Support. → Page 48, section »**Contact data**«.

Expect the formation of drops at the mechanical seal when operating with thermal fluids that evaporate only very slowly, as mechanical seals are never absolutely tight. These drops must be removed if necessary. → Page 40, section »**Function check and visual inspection**«. The tightness of the mechanical seal must be visually checked. In case of a leakage, more thermal fluid escapes at the bottom of the temperature control unit. Observe the proper disposal of thermal fluid. → Page 15, section »**Proper disposal of resources and consumables**«.

6.6 Plug contacts

NOTE

Exposed plug contacts

DAMAGE CAUSED BY FLUID INGRESS

- Protect unused plug contacts with the protective caps supplied.
- Clean surfaces only with a damp cloth.

Protective caps are supplied for all plug contacts. Make sure that any plug contacts not required are protective with the caps.

6.7 Decontamination/repairs

CAUTION

Returning a not decontaminated temperature control unit for repair

PHYSICAL INJURY AND PROPERTY DAMAGE CAUSED BY HAZARDOUS MATERIALS IN OR ON THE TEMPERATURE CONTROL UNIT

- Carry out appropriate decontamination.
- The decontamination process depends on the type and quantity of the materials used.
- Consult the relevant safety data sheet.
- You will find a prepared return receipt at www.huber-online.com.

As the responsible body you are responsible for carrying out decontamination **before** third-party personnel come into contact with the temperature control unit / accessory. Decontamination must be carried out **before** the temperature control unit / accessory is returned for repair or inspection. Attach a clearly visible written notice stating that the temperature control unit / accessory has been decontaminated.

To simplify the process, we have prepared a form for you. This is available for download at www.huber-online.com.

7 Shutting down

7.1 Safety instructions and basic principles



DANGER

Connection/adjustment to the power supply not carried out by an electrician and/or connection to a power socket without protective earth (PE)

MORTAL DANGER FROM ELECTRIC SHOCK

- Have the connection/adjustment to the power supply carried out by an electrician.
- Always connect the temperature control unit to safety sockets (PE).



DANGER

Damaged power cable/power cable connection

MORTAL DANGER FROM ELECTRIC SHOCK

- Do not start up the temperature control unit.
- Isolate the temperature control unit from the power supply.
- Have the power supply cable/power supply connection replaced and inspected by an electrician.
- Do not use a power cable that is longer than **3 m**.



WARNING

Risk of tipping due to unstable temperature control unit

SERIOUS INJURY AND PROPERTY DAMAGE

- Avoid risk of tipping due to unstable temperature control unit.



CAUTION

Non-compliance with the safety data sheet for the thermal fluid to be used

INJURIES

- Risk of injury to the eyes, skin, respiratory tract.
- The safety data sheet for the thermal fluid to be used must be read prior to using it and its content must be respected.
- Observe the local regulations/work instructions.
- Wear your personal protective equipment (e.g. temperature-resistant safety gloves, safety goggles, safety footwear).
- Danger of slipping because floor and work area are contaminated. Clean the workplace; observe the proper disposal of thermal fluid and aids. → Page 15, section »**Proper disposal of resources and consumables**«.



CAUTION

Hot or very cold thermal fluid

SEVERE BURNS/FROSTBITE OF LIMBS

- Before draining, ensure that the thermal fluid has room temperature (20 °C).
- If, at this temperature, the thermal fluid is too viscous to be drained: Control the temperature of the thermal fluid for a few minutes until the viscosity will allow drainage. Never control the temperature of the thermal fluid when the drain is open.
- Danger of burns when draining thermal fluids at temperatures above 20 °C.
- Wear your Personal Protective Equipment for draining.
- Only drain using suitable drainage hose and collecting container. These must be compatible with the thermal fluid and its temperature.

INFORMATION

All safety instructions are important and must be followed accordingly during working operations!

7.2 Switch-off

PROCEDURE

- Turn off the temperature control unit.
- Disconnect the temperature control unit from the power supply connection.

7.3 Draining the temperature control unit

PROCEDURE

- Drain the temperature control unit. → Page 37, section »Draining externally closed applications«.

7.4 Deinstalling the collecting container

PROCEDURE

- Remove the hose from the collecting container.
- Follow the instructions for the proper disposal of thermal fluid. → Page 15, section »Proper disposal of resources and consumables«.
- Dismantle the hose at the >Overflow< [12].

7.5 Uninstalling an external application

PROCEDURE

- Disconnect the external application from the temperature control unit.

7.6 Packing

Always use the original packaging! → Page 23, section »Unpacking«.

7.7 Shipping

NOTE

**Temperature control unit transported in a horizontal position
DAMAGE TO THE COMPRESSOR**

- Only transport the temperature control unit in an upright position.

NOTE

**Temperature control unit transported incorrectly
PROPERTY DAMAGE**

- Do not transport by truck on the castors or feet.
- Comply all requirements in this section to avoid damage to the temperature control unit.

Transport using the lugs, if fitted, on the top of the temperature control unit. Do not transport the temperature control unit alone and without aids.

- Always use the original packaging for transportation.
- Indicate the upright transport position with arrows on the packaging.
- Always transport the temperature control unit upright on a pallet!
- Protect attachments from damage during transportation!
- During transport, place the temperature control unit on squared timber to protect the casters/feet.
- Secure with tensioning belts/lashing straps that are suitable for the weight.
- Additionally secure (depending on model) with plastic film, cardboard and straps.

7.8 Disposal

CAUTION

Uncontrolled or incorrect opening of the coolant circuit

RISK OF INJURY AND ENVIRONMENTAL DAMAGE

- Work on the coolant circuit and disposal of the refrigerant must be carried out by approved refrigeration/air-conditioning system contractors.
- Please strictly observe: → Page 17, section »Temperature control units with fluorinated greenhouse gases/refrigerants«.

NOTE

Improper disposal

ENVIRONMENTAL DAMAGE

- Spilled/leaked thermal fluid must be discarded immediately and correctly. → Page 15, section »Proper disposal of resources and consumables«.
- To avoid environmental damage, have "disused" temperature control units disposed of exclusively by approved waste management companies (e.g. refrigeration and air conditioning companies).
- Please strictly observe: → Page 17, section »Temperature control units with fluorinated greenhouse gases/refrigerants«.

Huber temperature control units and Huber accessories are made of high quality, recyclable materials. For example: Stainless steel 1.4301 / 1.4401 (V2A), copper, nickel, FKM, Perbunan, NBR, ceramic, carbon, Al-Oxid, red brass, brass, nickel-plated brass and silver solder. Proper recycling of the temperature control unit and accessories can actively help reduce CO₂ emissions in the production of these materials. Follow the laws and regulations of your jurisdiction when disposing material.

7.9 Contact data

INFORMATION

Contact your supplier or local specialist retailer **prior** to returning the temperature control unit. The contact data can be found on our homepage www.huber-online.com under the heading „Contact“. Please keep the serial number of the temperature control unit ready. The serial number can be found on the nameplate of the temperature control unit.

7.9.1 Telephone number: Customer Support

If your country is not mentioned in the list below: The responsible service partner can be found on our homepage www.huber-online.com under the heading „Contact“.

- Huber Deutschland: +49 781 9603 244
- Huber China: +86 (20) 89001381
- Huber India: +91 80 2364 7966
- Huber Ireland: +44 1773 82 3369
- Huber Italia: +39 0331 181493
- Huber Swiss: +41 (0) 41 854 10 10
- Huber UK: +44 1773 82 3369
- Huber USA: +1 800 726 4877 | +1 919 674 4266

7.9.2 Telephone number: Sales

Telephone: +49-781-9603-123

7.9.3 Email address: Customer Support

Email: support@huber-online.com

7.10 Certificate of Compliance

This certificate must be enclosed with the temperature control unit. → Page 44, section »Decontamination/repairs«.

8 Annex

Inspired by **temperature** designed for you

Peter Huber Kältemaschinenbau SE
Werner-von-Siemens-Str. 1
77656 Offenburg / Germany

Telefon +49 (0)781 9603-0
Telefax +49 (0)781 57211

info@huber-online.com
www.huber-online.com

Technischer Service: +49 (0)781 9603-244

-125 °C ... +425 °C

huber