

Inspired by **temperature**



Extremely precise
temperature control solutions

for materials testing, quality assurance, environmental simulation
and much more

huber

The right solution for every Application



There are numerous applications for Huber temperature control systems in the aerospace, aviation and automobile industries. Typical applications include environmental simulations, material inspection, and temperature-dependent stress and load tests for materials, motors, bearings, fuel and engine parts.

Other common uses include research work, test series and quality controls on batteries, rechargeable batteries, sensors and electronic components. Researchers and engineers all over the world rely on our temperature control technology when constructing and operating test rigs.

Applications:

- Test rig construction
- Material testing
- Quality control
- Stress tests
- Environmental simulation
- Battery testing
- Solar technology
- Motor / bearing testing
- Calibration
- and much more



Temperature change tests

Small thermal regulation baths can be used for temperature change tests. Tests and pre-examinations can be carried out on material samples in the bath, quickly and easily. High-performance circulation thermostats are ideal for thermal tests that require a wide temperature range.

Various temperature conditions can be simulated, $-40\text{ }^{\circ}\text{C}$ to $85\text{ }^{\circ}\text{C}$ is a common test range but wider ranges are possible to as low as $-120\text{ }^{\circ}\text{C}$ up to $425\text{ }^{\circ}\text{C}$.



Test rigs

We supply individually designed temperature control equipment in every performance class for temperature tests on engines, drives, drivetrains and other components. Our temperature control solutions are ideal for integration into test rigs and deliver reproducible temperatures.

If a system division into primary and secondary circuits is required due to test rig requirements based on material incompatibilities, pressure, viscosity, flow rates etc, Huber can offer an option for design and delivery of external heat exchanger solutions in loose or built-on format.

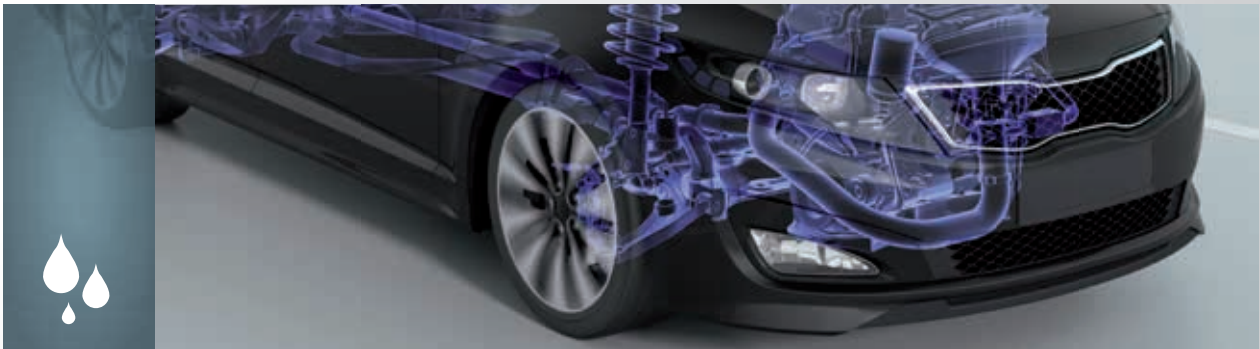

Addition/alternative to environmental chamber

Huber temperature control units are ideal as an alternative or extension to environmental chambers to lower their operational temperature range. Our temperature control units can be used in a wide range of tests, and often cost less than environmental chambers. Yet another benefit is the high temperature control speed which can be achieved with Unistats. Heating and cooling capacity can be trans-

ferred quickly and precisely – a critical advantage in many functional and material tests.

The combination of temperature control unit and environmental chamber allows simultaneous simulation of specimen temperatures as a function of environmental temperatures.



Temperature control solutions for Test rig construction, aviation



Battery Test

Functional tests for lithium ion rechargeable batteries in electric vehicles



Transmission oil test

Continual heating and cooling for durability testing



Calibration

Calibration tasks in the vehicle sensor area



Charpy Impact Test

Deformation capacity for components in air conditioning systems



Fogging Test

Measurement of volatile substances in materials used in vehicle interiors

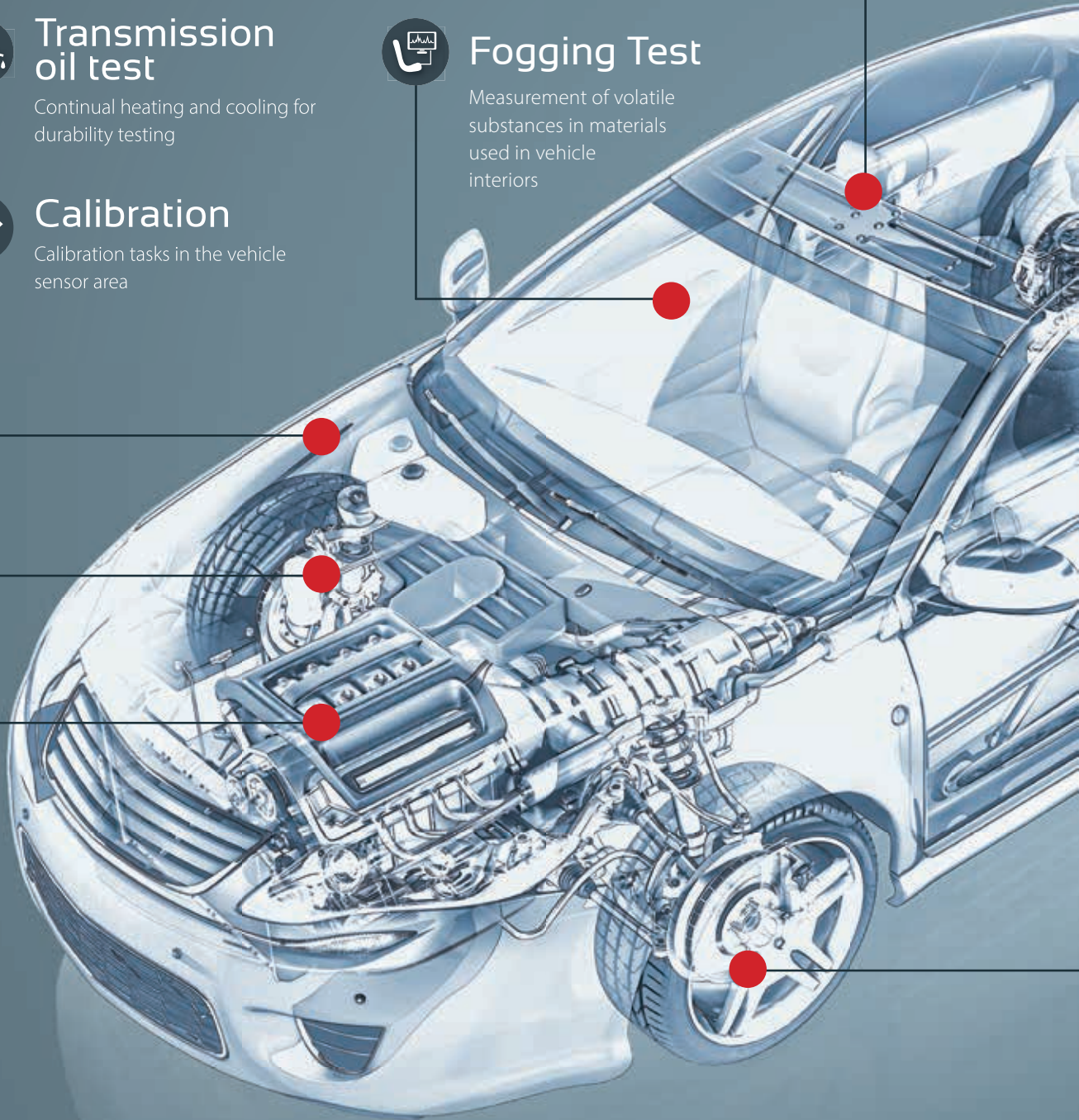

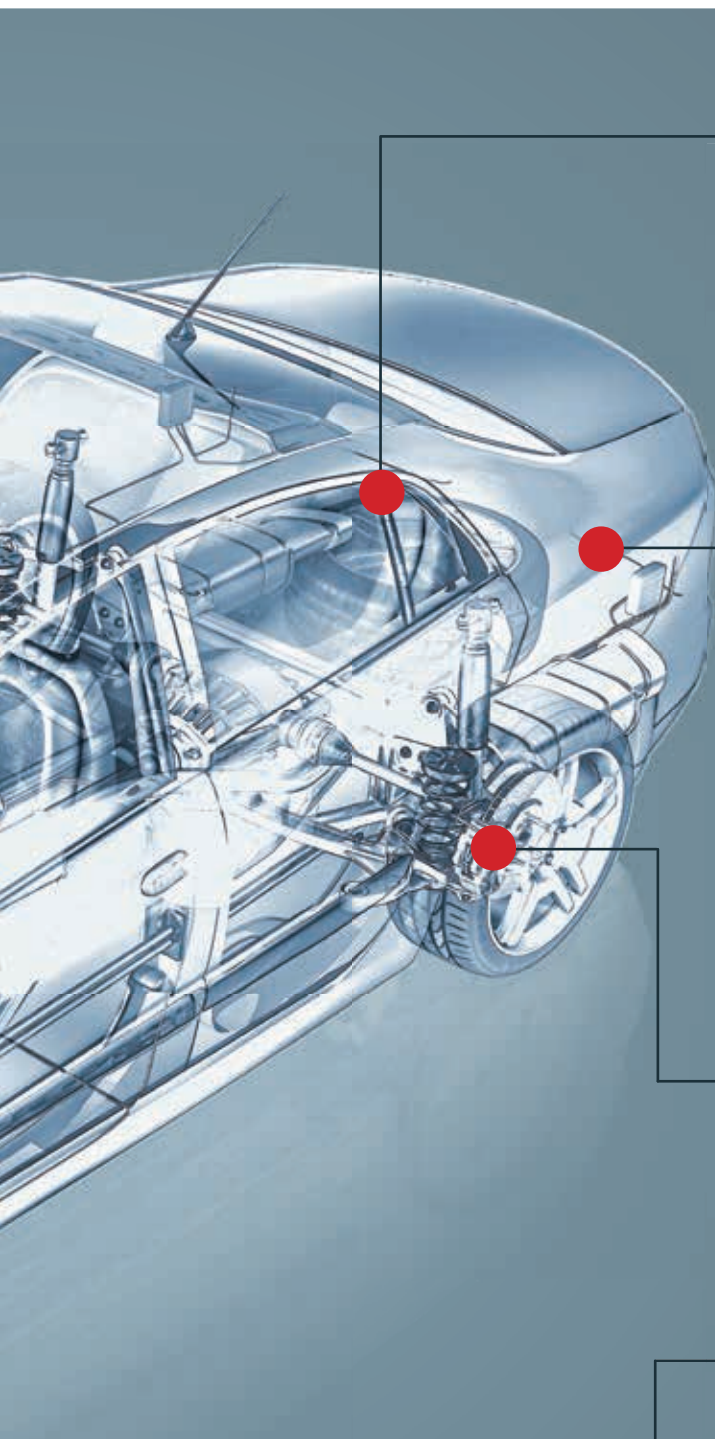

Vicat test

Tests for softening point for plastics



Cold filter plugging point

Determination of cold filter plugging point of diesel fuels



Fuel temperature control

Durability tests for fuel tanks



AdBlue[®] temperature control

Exhaust post-treatment of diesel fuels in cars



Stress test in test rigs

Long-term loading of vehicle components over several weeks under conditions of extreme temperatures



Corrosion testing

Corrosion testing with cyclical temperature fluctuation, moisture and saline vapour

Unimotive GL

GREEN LINE



▶ with CO₂-refrigerant

Unimotive GL is another milestone in the development of environmentally friendly refrigeration technology at Huber. The heating and cooling systems operate in a climate-friendly way using CO₂ as a refrigerant. Carbon dioxide (also known as R744) is a natural component of air and has proven itself in refrigeration technology since the 19th century.

CO₂ is a colourless gas that liquefies under pressure. It has no ozone depletion potential (ODP = 0) and has a minimal global warming potential (GWP = 1). As a natural refrigerant, CO₂ occurs in very large quantities in nature, i.e. it does not have to be produced at great energy expense. In addition, CO₂ has other advantages because it is nonflammable, non-toxic and chemically inactive.

- Natural refrigerant CO₂**
Environmentally friendly and climate-friendly
- Up to +95 °C**
Temperature range
- Up to 201 l/min**
Pump capacity
- Up to 56 kW**
Cooling power
- Pilot ONE**
Touch screen controller

- Direct operation with water-ethylene glycol mixture with corrosion protection (e.g. Glystantin®)
- Pilot ONE controller with 5.7" touchscreen and comfortable menu navigation
- 2x USB (Host, Device), Ethernet and RS232 interfaces
- With E-grade "Professional" as standard
- Precise and reproducible temperature control results
- Adaptive temperature control, self-optimising
- Efficient operation saves working time and operating costs
- Fastest heating and cooling rates
- Robust, magnetic coupled circulation pump
- Proven Unistat technology

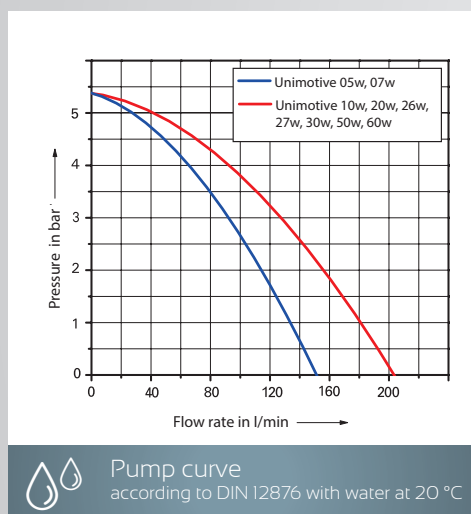

All Unimotive models are designed for direct operation with a water-ethylene glycol mixture with corrosion protection (e.g. Glystantin®)

Model	Temperature range (°C)	Pump max. VPC		Heating power (kW)	Cooling power (kW) at (°C)*				Dimensions WxDxH (inch)	Cat.No.	G	Power Supply
		(l/min)	(bar)		20	0	-20	-40				
Unimotive GL 05w	-45...95	150	5,3	6,0	5,0	4,0	2,4	0,7	28,7x31,7x68,4	5030.0003.01	4	460V 3~ 60Hz
Unimotive GL 07w	-45...95	150	5,3	12,0	12,0	10,0	7,0	2,5	28,7x31,7x68,4	5031.0003.01	4	460V 3~ 60Hz
Unimotive GL 10w	-45...95	201	5,3	24,0	21,5	17,5	11,5	4,5	28,7x31,7x68,4	5008.0003.01	4	460V 3~ 60Hz
Unimotive GL 20w	-45...95	201	5,3	24,0	28,0	25,0	18,6	6,8	36,1x37,9x69,7	5033.0003.01	5	460V 3~ 60Hz
Unimotive GL 30w	-45...95	201	5,3	24,0	35,0	35,0	22,0	8,5	36,1x37,9x69,7	5009.0003.01	5	460V 3~ 60Hz
Unimotive GL 50w	-45...95	201	5,3	24,0	40,0	35,0	31,0	14,0	36,1x37,9x69,7	5032.0003.01	5	460V 3~ 60Hz
Unimotive GL 60w	-45...95	201	5,3	48,0	56,0	48,0	34,0	18,0		5034.0003.01	5	460V 3~ 60Hz

Other models using natural refrigerants are available on request

Unimotive GL-XT





GREEN LINE



▶ with additional system pressure

The 'Unimotive XT' high-temperature variants are designed for working temperatures of up to +150 °C. Unimotive XT works with a unique, fully integrated and variable pressure overlay that sets new standards.

The overpressure in the fluid circuit can be set to a fixed value or as a ramp for the ranges above the standard boiling point. The variable pressure superimposition reduces the load on the application at low temperatures due to the lower system pressure. No special infrastructure (e.g. nitrogen gas tanks or similar) is required for operation and the expansion vessel remains unpressurised, which simplifies the risk assessment.

-  **Variable pressure overlay**
fully integrated, no further infrastructure required
-  **Up to +150 °C**
Temperature range
-  **Up to 201 l/min**
Pump capacity
-  **Up to 56 kW**
Cooling power
-  **Pilot ONE**
Touch screen controller



Model	Temperature range (°C)	Pump max. VPC		Heating power (kW)	Cooling power (kW) at (°C)*				Dimensions W x D x H (inch)	Cat.No.	G	Power Supply
		(l/min)	(bar)		20	0	-20	-40				
Unimotive GL 05w-XT	-45...150	150	5,3	6,0	5,0	4,0	2,4	0,7	28,7x31,7x68,4	5030.0004.01	4	460V 3~ 60Hz
Unimotive GL 07w-XT	-45...150	150	5,3	12,0	12,0	10,0	7,0	2,5	28,7x31,7x68,4	5031.0004.01	4	460V 3~ 60Hz
Unimotive GL 10w-XT	-45...150	201	5,3	24,0	21,5	17,5	11,5	4,5	28,7x31,7x68,4	5008.0004.01	4	460V 3~ 60Hz
Unimotive GL 20w-XT	-45...150	201	5,3	24,0	28,0	25,0	18,6	6,8	36,1x37,9x69,7	5033.0004.01	5	460V 3~ 60Hz
Unimotive GL 30w-XT	-45...150	201	5,3	24,0	35,0	35,0	22,0	8,5	36,1x37,9x69,7	5009.0004.01	5	460V 3~ 60Hz
Unimotive GL 50w-XT	-45...150	201	5,3	24,0	40,0	35,0	31,0	14,0	36,1x37,9x69,7	5032.0004.01	5	460V 3~ 60Hz
Unimotive GL 60w-XT	-45...150	201	5,3	48,0	56,0	48,0	34,0	18,0		5034.0004.01	5	460V 3~ 60Hz

Other models using natural refrigerants are available on request

Flow measurement and control

Flow Control Cube

The Flow Control Cubes are used to measure and control the flow and pressure of the thermal fluid. They can be used with Huber temperature control units with Pilot ONE technology.

Flow measurement is magnetic-inductive (MID models) or via a turbine (TURB models).

	Flow Control Cube MID¹ ▶ Flow measurement magnetically-inductive	Flow Control Cube CORE I ▶ Flow measurement via Coriolis
Temperature range	-40 ... 130 °C	-40 ... 150 °C
Permitted fluids	Water or Water-/glycol mixtures	Water-/glycol mixtures
Accuracy flow control ²	up to ± 0,1 l/min	bis zu ± 0,2 l/min
Min. volume flow	0,2 l/min	0,2 l/min
Max. volume flow	80 l/min	95 l/min
Max. permitted pressure	6,0 bar	12,0 bar
Dimensions WxDxH	16,5x21,2x23,3 inch	16,5x21,2x23,3 inch
Weight, netto	approx. 49 kg	
Noise level	approx. 43 dB (A)	ca. 43 dB (A)
Fluid connection	M38x1,5 AG	M38x1,5 AG
Power supply	90–240V 1~50/60Hz	90–240V 1~50/60Hz
Max. current	0,2 A	0,2 A
Fuse protection	2,0 A	2,0 A
Protection class	IP20	IP20
Min. ambient temperature	5 °C	5 °C
Max. ambient temperature	40 °C	40 °C
Suitable for units	Unimotive	Unimotive XT series
Construction / Design	On castors, loose ³	
Cat.No.	3601.0006.00	3601.0020.00

¹ Due to the technology used, the MID and CORE does not have to be explicitly matched to the medium used

² At 20 °C and water-glycol mixture 50/50. The accuracy is influenced by various factors (in particular the set flow rate, the fluid used, the fluid temperature).

³ Accessories for use with the FCC e.g. hoses, adapters, etc. must be ordered separately



CORE is suitable for Unimotive XT



BACK VIEW

Interface options:
 RS232/485, USB, Ethernet,
 Modbus TCP, Profibus, OPC-UA

SINGLE-CIRCUIT CONTROL WITH FCC

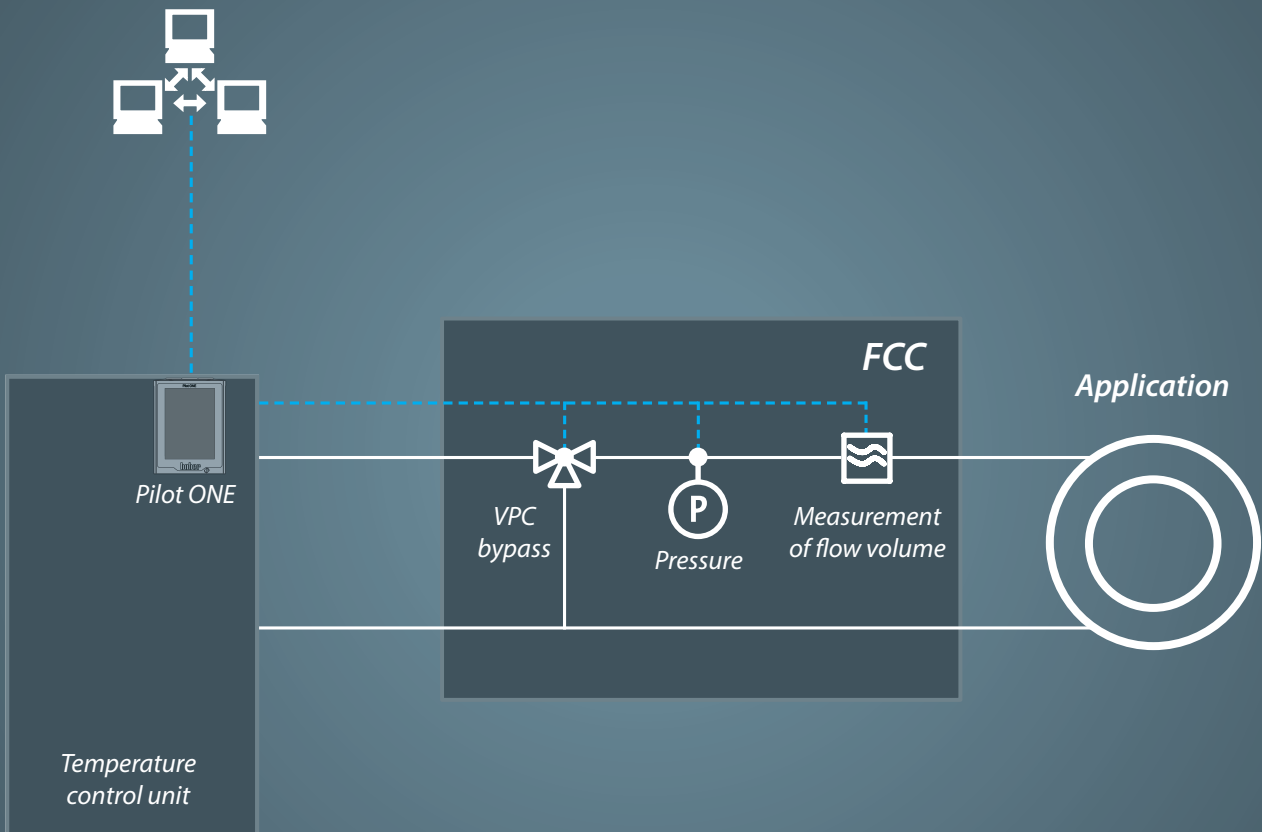

--- Data communication
 — Thermofluid

Flow measurement and control

3-way Flow Control Cube

The 3-way Flow Control Cubes measure and regulate the flow and pressure of the thermal fluid. Unlike the FCC, they have their own controller and therefore operate independently, without communicating with the Pilot ONE of the

temperature control unit. This enables multi-loop control. Flow control is performed with an accuracy of ± 0.1 l/min at a flow rate of 0.2 to 80 l/min.

	Multi Flow Control Cube 3x MID¹ ▶ Flow measurement magnetically-inductive
Temperature range	-45 ... 150 °C
Permitted fluids	Water or Water-/glycol mixtures
Accuracy flow control ²	up to $\pm 0,1$ l/min
Min. volume flow	0,2 l/min
Max. volume flow	80 l/min
Max. permitted pressure	6,0 bar
Dimensions WxDxH	21,2x30,3x33,5 inch
Fluid connection	M38x1,5 AG
Power supply	90–240V 1~/2~ 50/60Hz
Protection class	IP20
Min. ambient temperature	5 °C
Max. ambient temperature	40 °C
Suitable for units	Unimotive
Cat.No.	3601.0024.01

¹ Due to the technology used, the MID and CORE does not have to be explicitly matched to the medium used

² At 20 °C and water-glycol mixture 50/50. The accuracy is influenced by various factors (in particular the set flow rate, the fluid used, the fluid temperature).



*Do you need more control loops?
We'd be happy to help you find the right solution.*

Interface options:
RS232/485, USB, Ethernet,
Modbus TCP, Profibus, OPC-UA

MULTI-CIRCUIT CONTROL WITH 3-WAY-FCC

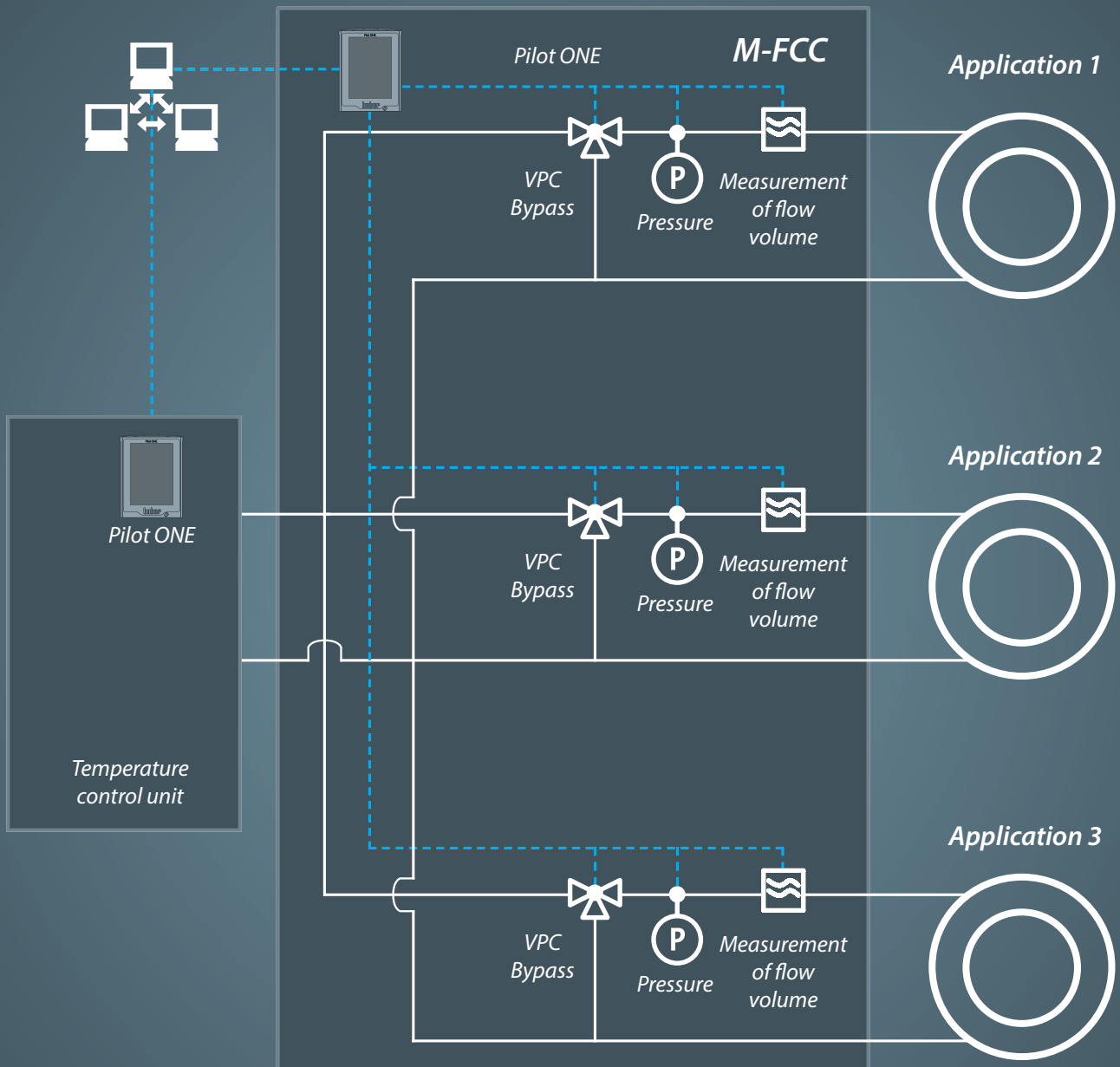

--- Data communication
— Thermofluid

HXP (Heat Exchange Pump)

POSSIBLE DESIGNS

The individually designed HXP (Heat Exchange Pump) unit can be used for high viscosity fluids according to your requirements. The core components of the unit consist of a pump, a heat exchanger, a Pilot ONE and an FCC bypass. The heat exchanger and pump can be designed to meet individual customer requirements. With the help of the Pilot ONE, integration into a control system is possible.

In addition, the following interfaces are available:

PT100 connection

Connection for an external pressure transmitter

POKO/Alarm

AIF REG+E-Prog

ECS Standby

RS232

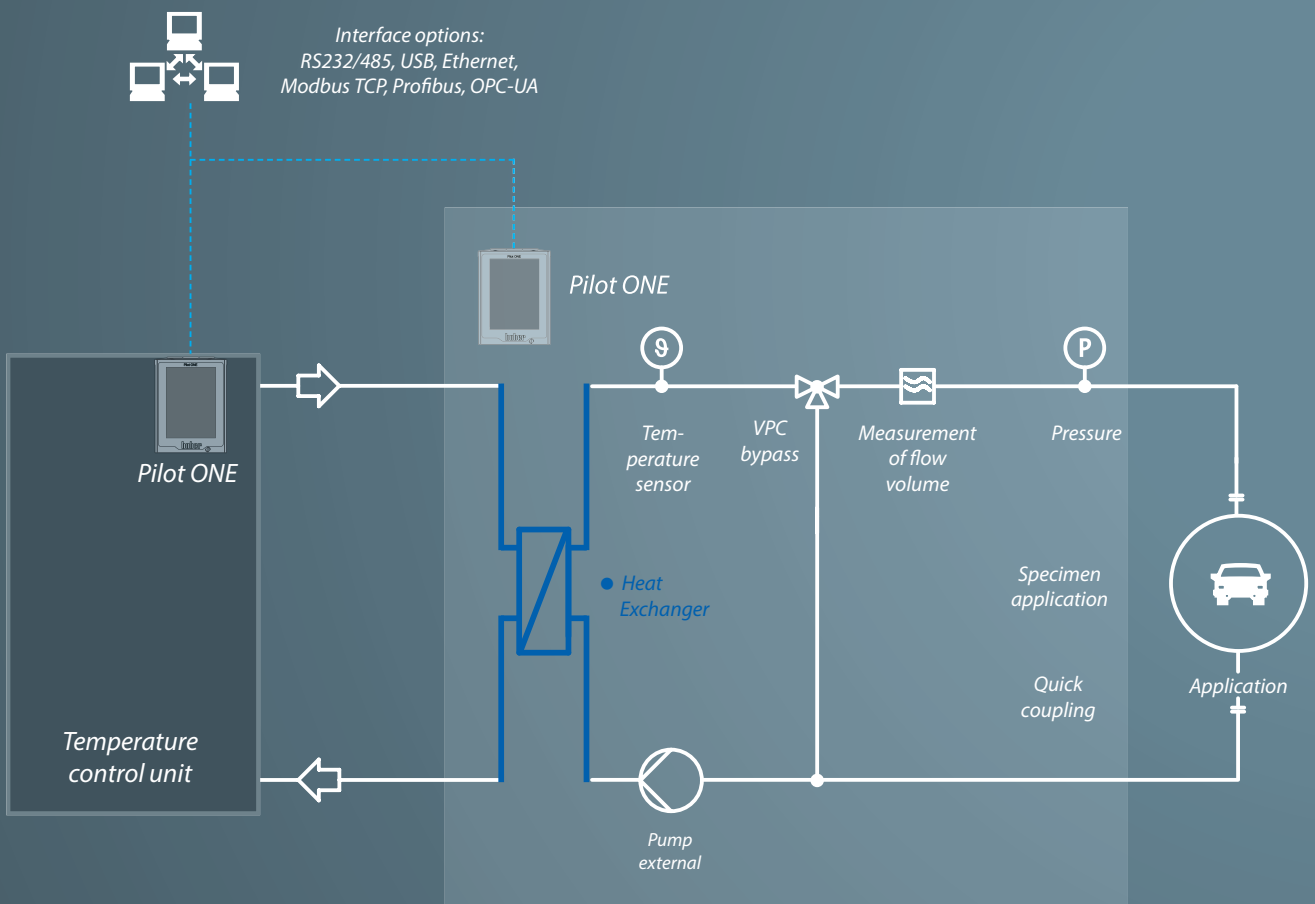

Option **ADR** (Automated Drain & Refill System)

INTEGRATION WITH FCC

The ADR can only be controlled with a control system. If an FCC is also used, a CAN switch is required so that the FCC and ADR can be connected to the temperature control unit. The 15-pin socket available in the unit is used.

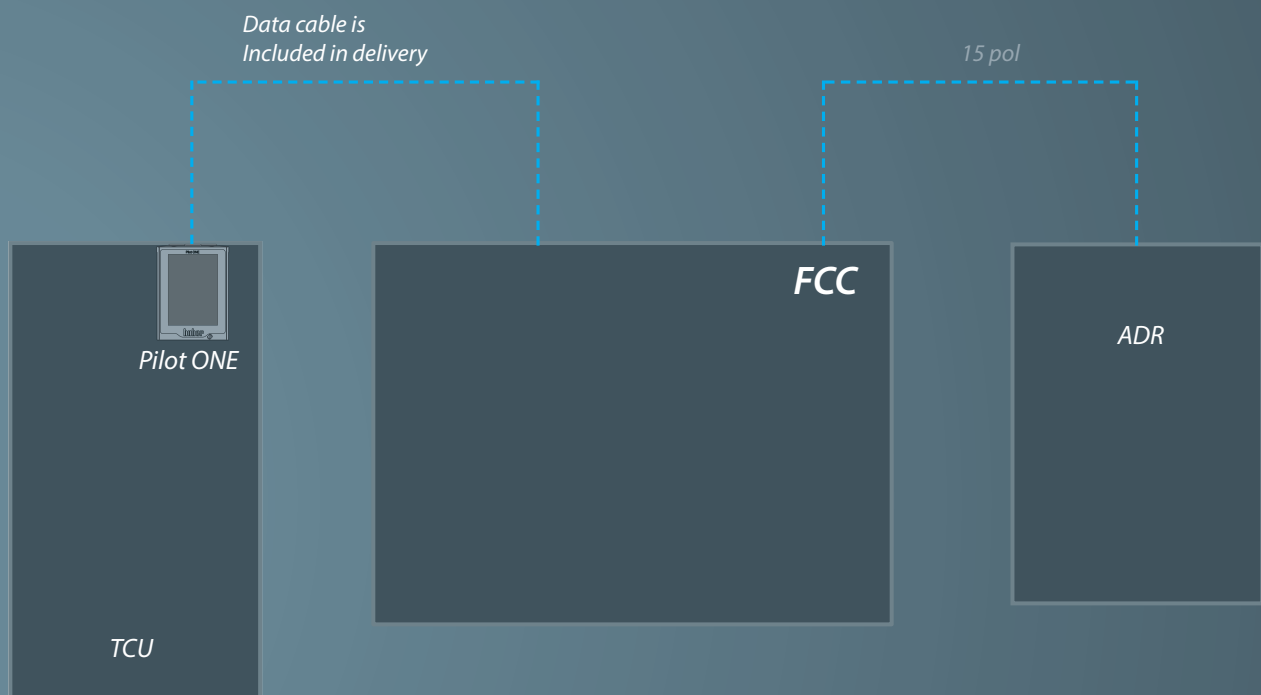

Model		Cat.No.
ADR		3602.0001.00
Connection cable	Standard: 3 m Optional: 5 m / 10 m / 15 m / 20 m / 25 m / 30 m	16160
Additional expansion vessel	Filling capacity: 30 litre	525324

Option **ADR** (Automated Drain & Refill System)

FUNCTIONALITY

With the ADR solution, the connected application can be emptied with compressed air and changed in a time-saving manner with the aid of quick couplings. The blown-out thermal fluid is returned to the temperature control unit and can be reused. The system can be used for Unimotive and Unichiller with water-glycol. The valves installed in the ADR unit are electrically controlled. When inquiring, please specify the unit used with serial number.

A safety device against overpressure is not included in the scope of delivery.

Interface options:
RS232/485, USB, Ethernet,
Modbus TCP, Profibus, OPC-UA

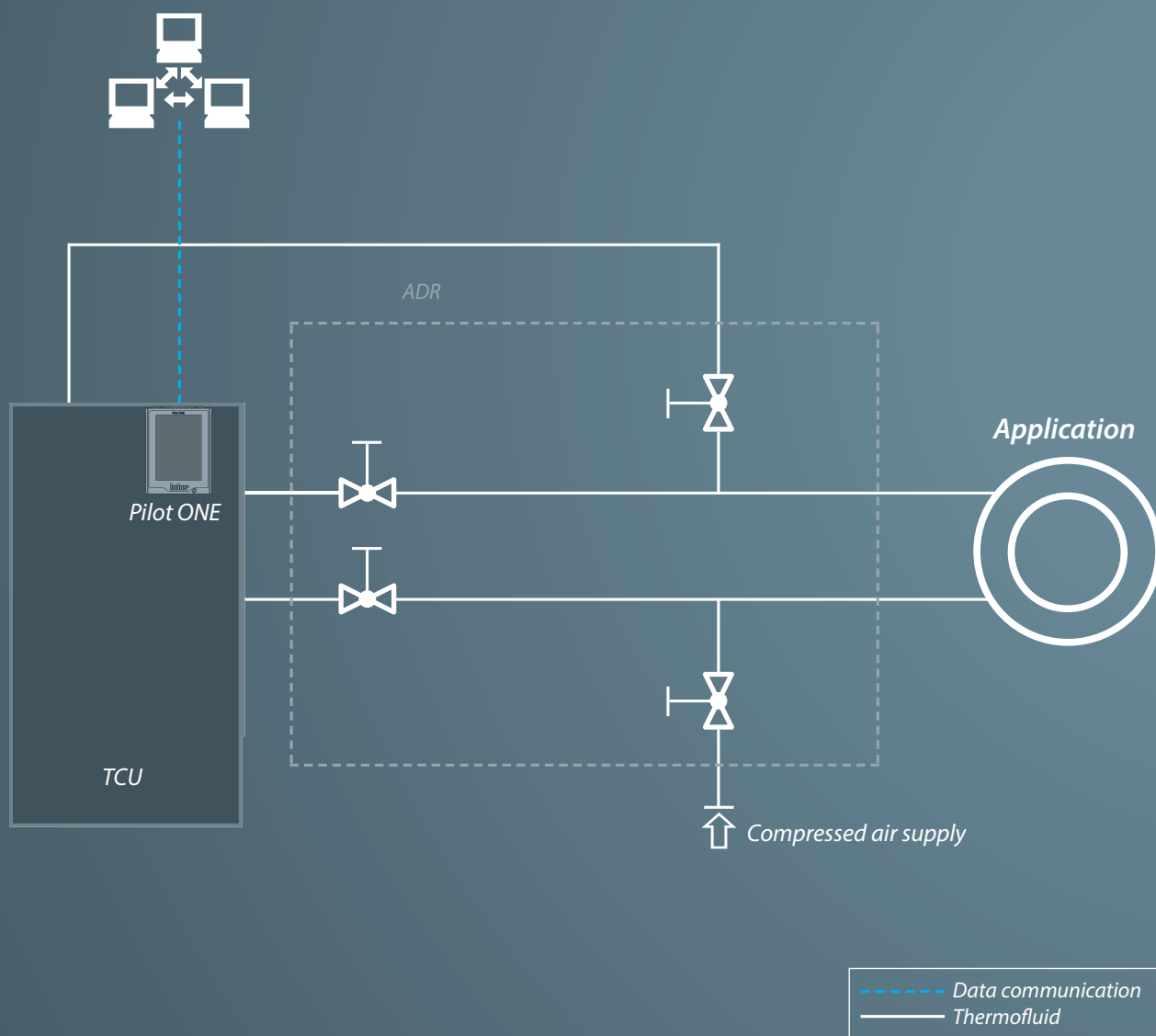

POSSIBLE DESIGNS

The valves installed in the „ADR“ solution are available with electrical control or compressed air control. For the alternative control with compressed air, an additional valve terminal is required to control the valves, which is not included in the scope of delivery.

The schematic drawings on this double page show the basic operation for standard applications (left side), for applications with FCC (right side).

The ADR can be connected to the temperature control unit via a 15-pin interface.

Interface options:
RS232/485, USB, Ethernet,
Modbus TCP, Profibus, OPC-UA

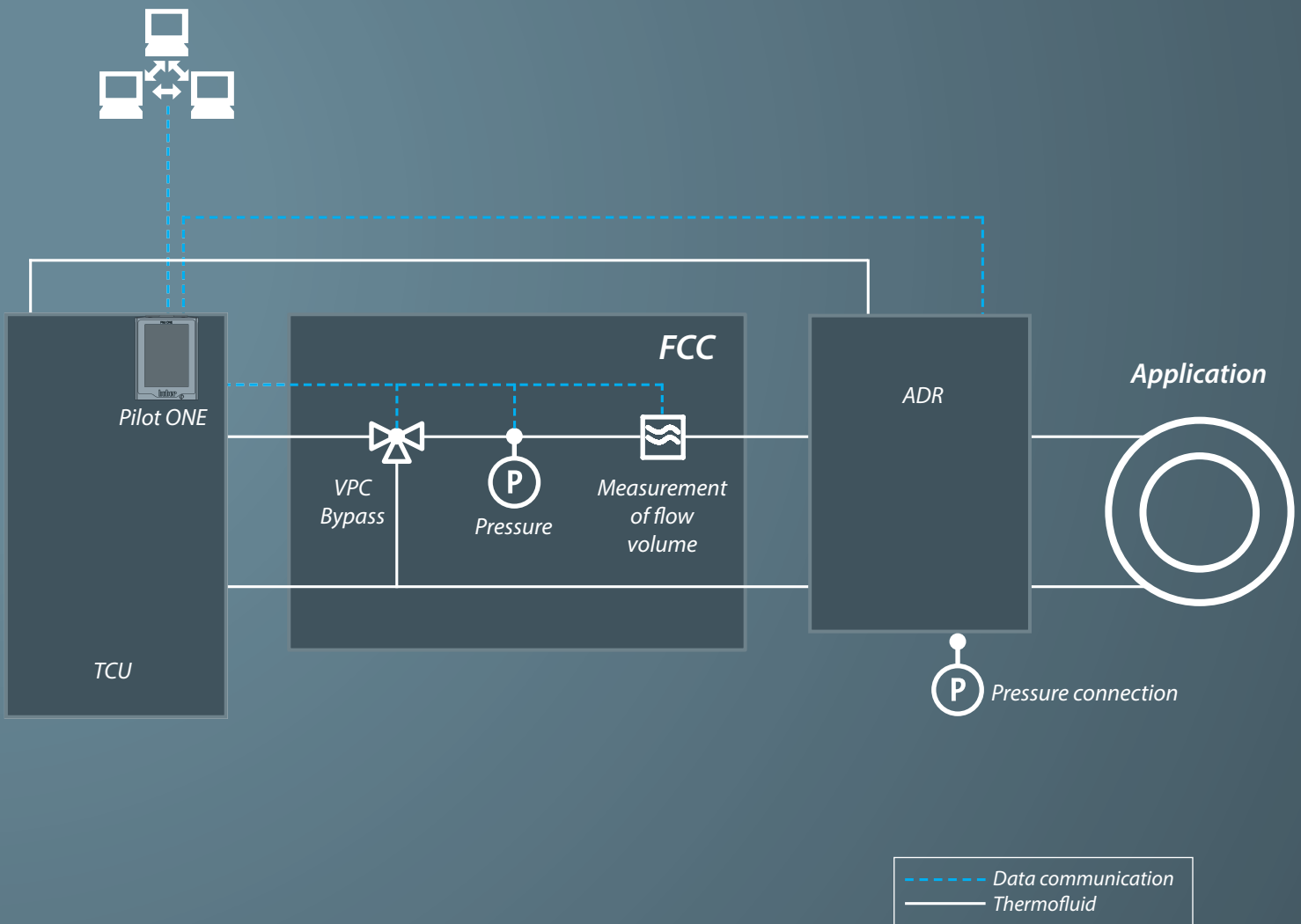

Special Solutions

ATTACHMENTS ON THE BACK

The optionally available components such as flow meter, bypass, etc. can be mounted by the customer or installed directly on the device to save space (ex works), depending on the requirements.

We will be pleased to design a suitable solution for your application in consultation with you. It is possible to mount the attachments on the back of the unit, on the side, on top or as an external unit.

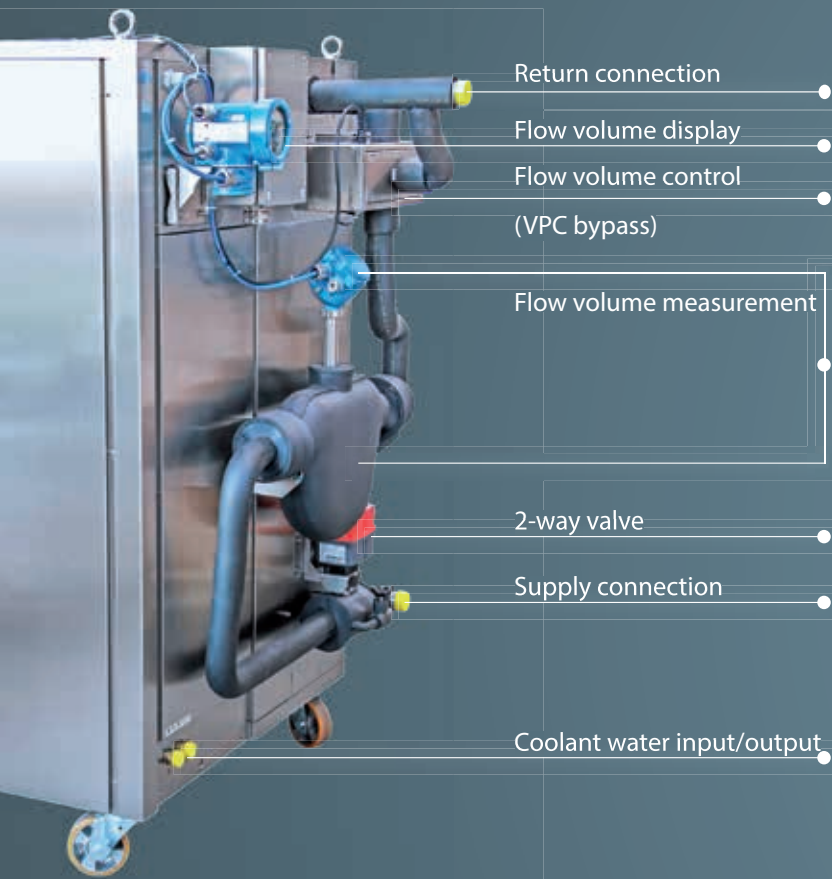

MODELS „ON TOP“

In these models, all additional components are installed on the temperature control unit.

Advantage:

The temperature control unit does not require any additional floor space and can therefore be easily and can therefore be set up easily and in a space-saving manner. Integrated into the surface-mounted housing are, among other things, bypass, flow meter, interfaces, etc.

Heat exchanger

DIRECT OPERATION OR WITH HEAT EXCHANGER

Basically, two operating variants are available for the temperature control unit. Variant 1 is operation via an external heat exchanger. Advantage: Application circuit and temperature control circuit are separated and any temperature control fluid can be used on the application side. Variant 2 is direct operation, e.g. with water-glycol, 3M Novec or other permissible temperature control media.

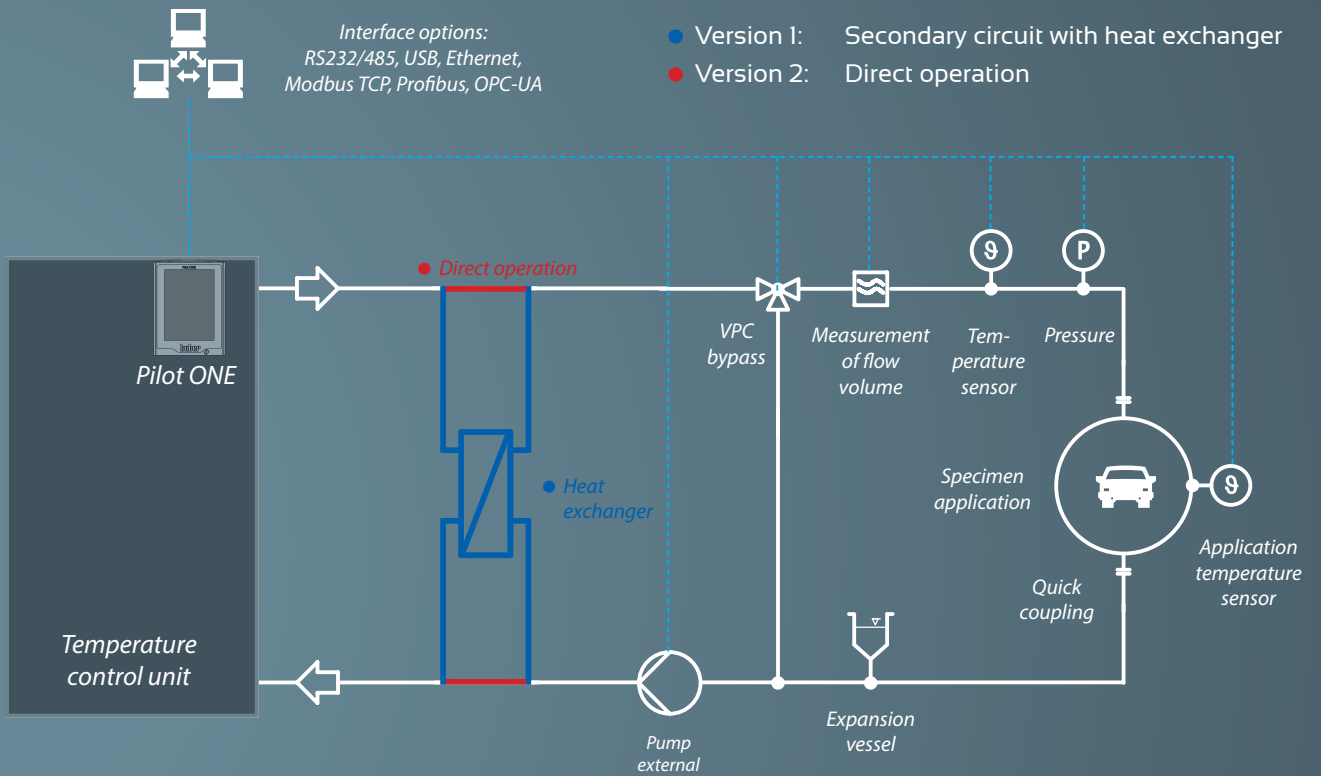

HEAT EXCHANGER

External heat exchanger for separation of fluid circuits of temperature control unit and application allow indirect operation with almost all temperature control liquids (e.g. in the event of viscosity problems, material incompatibilities).



Interfaces PROFINET gateway



PROFINET (Process Field Network) is the open Industrial Ethernet standard of the PROFIBUS user organisation e. V. (PNO) based on Ethernet-TCP/IP and complements Profibus technology for applications that require fast data communication via Ethernet networks in combination with industrial IT functions. PROFINET can be used to implement solutions for manufacturing technology, process automation, building automation and the entire spectrum of drive technology. With the PROFINET gateway, Huber temperature control units can be integrated into PROFINET networks easily, flexibly and close to the process. The PROFINET gateway is integrated into the project planning software with the aid of the associated GSDML file.

PROFINET-side

Ethernet-side

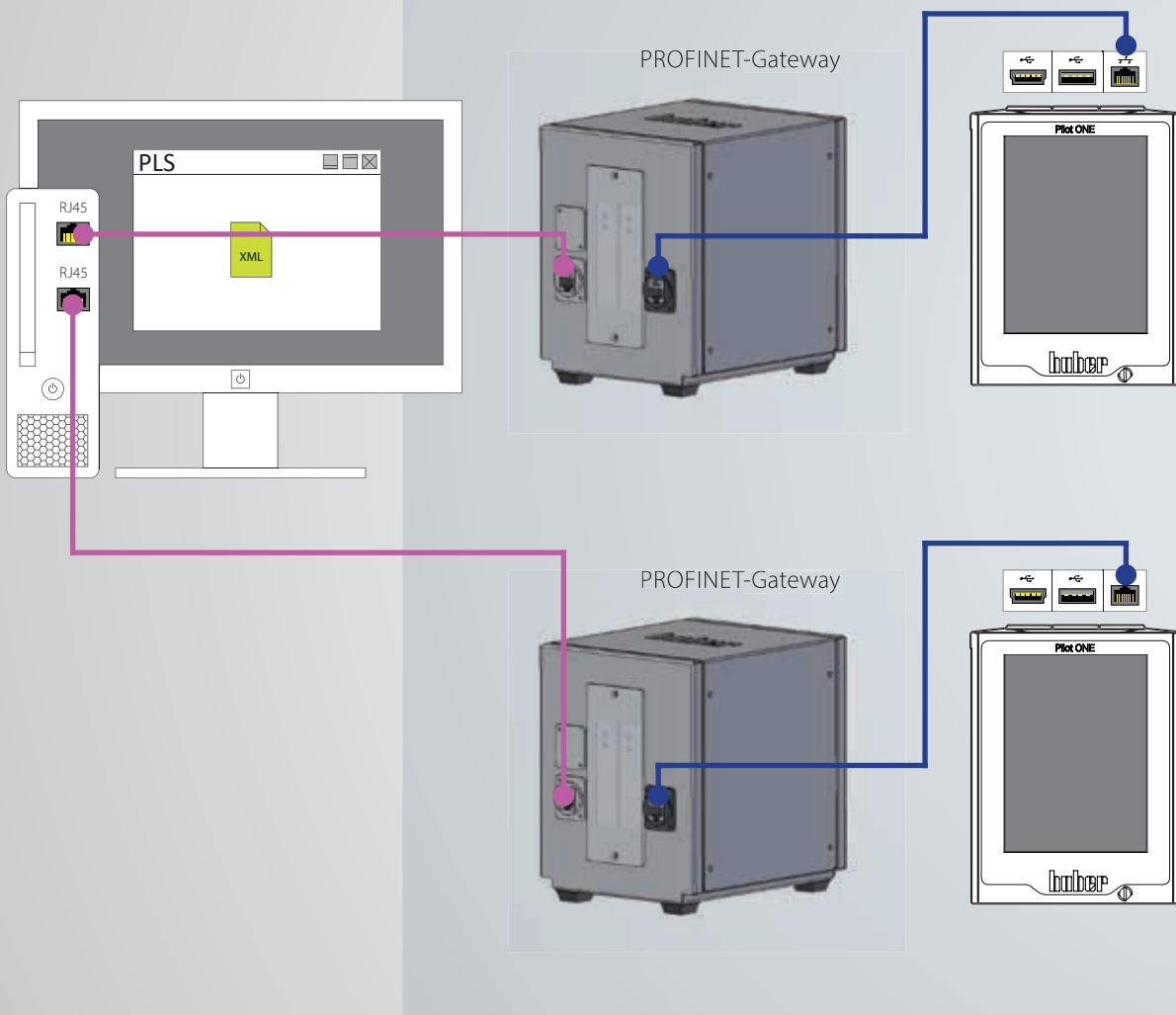

Model	Cat.No.
PROFINET-Gateway	10965

Interfaces EtherCAT gateway



EtherCAT, short for Ethernet for Control Automation Technology, is an open Ethernet-based fieldbus technology that is standardised in international standards. EtherCAT is a very fast Industrial Ethernet system that is also suitable for use in time-critical applications. With the EtherCAT gateway, Huber temperature control units can be integrated into EtherCAT networks easily, flexibly and close to the process. The EtherCAT gateway is integrated into the configuration software with the aid of the associated GSDML file.

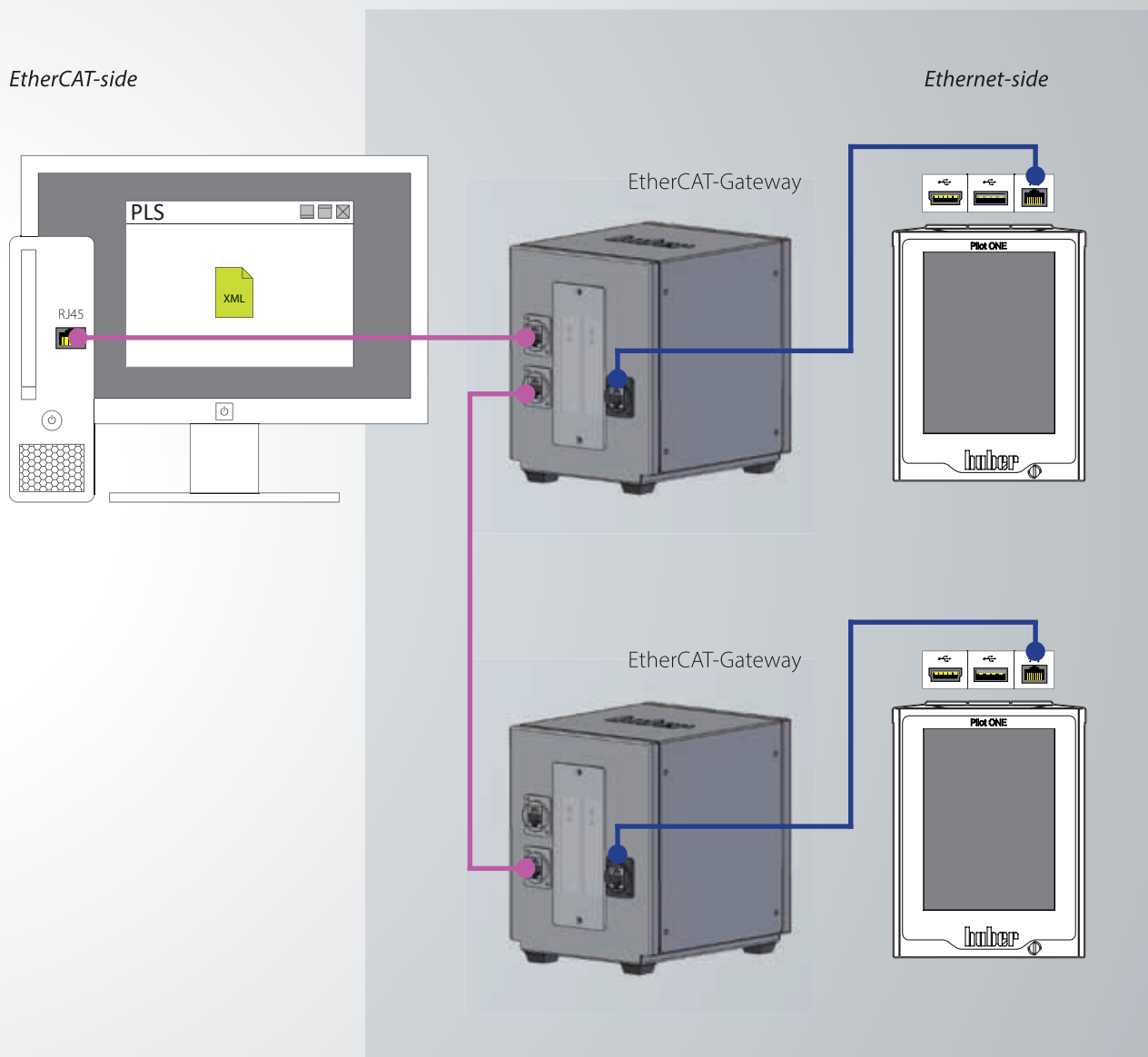

Model	Cat.No.
EtherCAT-Gateway	10966

Individually configurable Options for your application



AUTOMATION

Support for common data communication standards and software solutions for data recording, remote operation and programming.

Interfaces: e.g. Profibus, Modbus TCP, Ethernet, OPC-UA, RS232, RS485, USB, Analogue.



CIRCULATION PUMPS

Various pump options and optional pressure booster pumps allow flexible alignment of pressure and flow volume for the application.



SENSOR OPTIONS

A selection of Pt100 sensors for temperature measurement and regulation at relevant points.



DRY CONNECT/ DISCONNECT

Press & Twist connections make it easier to change the application on the temperature control unit. Having a wide internal bore the pressure drop is low keeping flow resistance to a minimum to promote efficient thermal transfer and temperature control.



WATER GLYCOL

Direct operation with water glycol as a temperature control medium is possible with many Unistats, as well as use of electrically non-conductive liquids (e.g. 3M Novec).



EXPANSION

A range of expansion vessels is available as accessories for compensation of temperature-dependent volume changes.



MEASUREMENT AND CONTROL OF HTF

VPC bypasses and various flow rate meters allow measurement and control of heat transfer fluid (HTF) pressure and flow volume.



CONNECTION SETS

Preconfigured sets consisting of T-bend and pipe extension for connecting additional M-FCC Flow Control Cubes.



Examples of use



Fuel temperature control

Huber temperature control equipment is used for cyclical heating/cooling of petrol or diesel. Dynamic temperature control systems are particularly suitable for this test, as they can change temperature quickly and cover a wide temperature range.



Cold filter plugging point

The most important test for the cold temperature resistance of the diesel fuel is the filter performance defined by the CFPP or Cold Filter Plugging Point Test in accordance with EN 116. At temperatures below the freezing point, paraffin crystals can increase the flow resistance in the fuel filter, reducing or stopping the flow of fuel.



Material deformation

Components such as condensers, air lines and exhausts are frequently exposed to temperature fluctuations from $-90\text{ }^{\circ}\text{C}$ to $+150\text{ }^{\circ}\text{C}$. The behaviour of the materials in the different components can be tested with cold bath circulation thermostats under a range of load conditions.



AdBlue[®] temperature control

This application takes place in the SCR (selective catalytic reduction) catalytic converter. Using selective catalytic reduction, the emission of nitrogen oxide (NO_x) is reduced by around 90% (in stationary operation). The liquid is a clear, synthesised 32.5 percent solution of high-purity urea in demineralised water.



Exhaust test

We supply a range of different temperature control units for fogging tests (in accordance with EN 14288 and DIN 75201) for individual components in car interiors.

When they warm up, the volatile constituents escape from the component and condense in the (colder) environment.

The KISS and CC series are used to heat the sample while the (e.g.) Minichiller is used to condense the vapours for analysis.



Transmission oil test

For transmission oil tests, you can use a Unistat with operational temperatures from -40 °C to $+250\text{ °C}$ for temperature control. The transmission oil is pumped through a plate heat exchanger and flows through defined temperature profiles in various cycles.



Softening point

The Vicat Test is used to make statements about the softening point of plastics. A rounded needle with a flat end is pressed onto the sample with a defined pressure and continuous increase in ambient temperature. Depending on the test conditions chosen, the constant temperature increase must be 50 °C or 120 °C per hour, until the softening temperature (VST) is reached, and the needle can penetrate 1 mm into the material.

Examples of use



Optics, telescopes

Unistats are used for high-precision temperature control of calibration and vacuum chambers, in order to test and calibrate optical telescopes for space research. The parts and functional components are subjected to real conditions using high vacuum systems.



Additives, lubricants

Temperature-dependent test processes for development, optimisation and quality assurance of additives and lubricants. Typical objectives include improving the cold temperature behaviour of viscosity as well as optimisation of resistance to ageing, corrosion protection, dispersing capacity and foaming behaviour.



Pump test

Temperature control for pump test units for pumps for liquid and gaseous media. Exact temperature control delivers a high level of measurement accuracy and reproducibility for all parameters. Typical tests where the influence of temperature plays a major role include pressure tests, flow volume measurements, noise measurements, power consumption, leak tests and long-term durability tests.



Sensors

Unistats combined with the Unical calibration bath are ideal for functional testing and calibration of sensors such as Pt100 sensors. The stainless-steel bath is set up like a calorimeter, and so achieves excellent temperature homogeneity.

The individual temperature cycles can be prescribed using a programmer or control via a digital interface.



Corrosion testing

Vehicle chassis components are exposed to temperature fluctuations, moisture and environmental influences every day. These environmental conditions are recreated in special test chambers using mist, dry phases, salt solutions and other corrosive solutions.

The cyclical temperature fluctuations are critical here. Dynamic temperature units from Huber are ideal here, to test precise temperature changes over several test phases.



Material stress test

In the automotive industry, all vehicle components must undergo a wide range of stress tests - often under extreme climatic conditions. The components must be able to withstand the stress of cyclical, changing temperatures for several weeks or months. Unistats are the perfect choice here. The units are designed for reliable, permanent operation, and facilitate extremely rapid temperature change.



Battery test

One use of lithium ion batteries is in electric vehicles. These must pass a range of temperature tests before installation. For this, an ambient temperature from -20 °C to +40 °C is created in an environmental chamber. A Unistat, which can control temperature from -40 °C to +100 °C, is connected at a test point inside the environmental chamber using hoses.



Special solutions

If you need a temperature control solution specially adapted to your requirements, then we look forward to your enquiry. We would be delighted to offer personalised advice and give you suitable approaches to a solution, or show you reference projects we have already completed with comparable requirements.

Notes

Inspired by **temperature** designed for you



We would be delighted to solve your temperature control task.
We look forward to your enquiry.

Huber USA Inc.
1101 Nowell Rd Ste 110
Raleigh, NC 27607

info@huber-usa.com
www.huber-usa.com

Sales Hotline: +1 800-726-4877
Mo-Fr: 8 am to 5 pm E.S.T.
sales@huber-usa.com

24/7 Service Hotline: +1 844-233-8673
support@huber-usa.com